

LM2852

2A 500/1500kHz Synchronous SIMPLE SWITCHER® Buck Regulator

General Description

The LM2852 SIMPLE SWITCHER® synchronous buck regulator is a high frequency step-down switching voltage regulator capable of driving up to a 2A load with excellent line and load regulation. The LM2852 can accept an input voltage between 2.85V and 5.5V and deliver an output voltage that is factory programmable from 0.8V to 3.3V in 100mV increments. The LM2852 is available with a choice of two switching frequencies - 500kHz (LM2852Y) or 1.5MHz (LM2852X). It also features internal, type-three compensation to deliver a low component count solution. The exposed-pad TSSOP-14 package enhances the thermal performance of the LM2852.

Features

- Input voltage range of 2.85 to 5.5V
- Factory EEPROM set output voltages from 0.8V to 3.3V in 100mV increments
- Maximum load current of 2A
- Voltage Mode Control
- Internal type-three compensation
- Switching frequency of 500kHz or 1.5MHz
- Low standby current of 10µA
- Internal 60 mΩ MOSFET switches
- Standard voltage options 0.8/1.0/1.2/1.5/1.8/2.5/3.3 volts

Applications

- Low voltage point of load regulation
- Local solution for FPGA/DSP/ASIC core power
- Broadband networking and communications infrastructure
- Portable computing

Typical Application Circuit

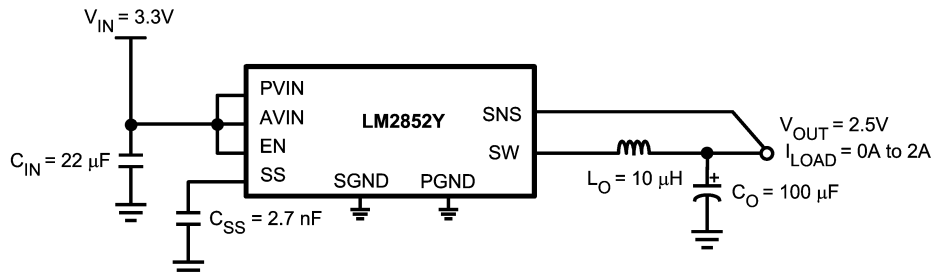

20127001

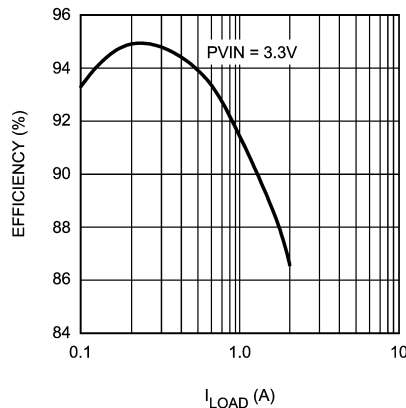

20127002

SIMPLE SWITCHER®
SIMPLE SWITCHERReg; is a registered trademark of National Semiconductor Corporation

Connection Diagram

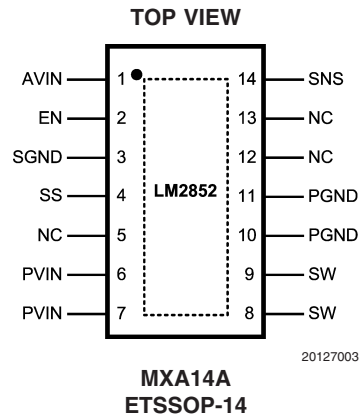

Pin Descriptions

AVIN (Pin 1): Chip bias input pin. This provides power to the logic of the chip. Connect to the input voltage or a separate rail.

EN (Pin 2): Enable. Connect this pin to ground to disable the chip; connect to AVIN or leave floating to enable the chip; enable is internally pulled up.

SGND (Pin 3): Signal ground.

SS (Pin 4): Soft-start pin. Connect this pin to a small capacitor to control startup. The soft-start capacitance range is restricted to values 1 nF to 50 nF.

NC (Pins 5, 12 and 13): No connect. These pins must be tied to ground or left floating in the application.

PVIN (Pins 6, 7): Input supply pin. PVIN is connected to the input voltage. This rail connects to the source of the internal power PFET.

SW (Pins 8, 9): Switch pin. Connect to the output inductor.

PGND (Pins 10, 11): Power ground. Connect this to an internal ground plane or other large ground plane.

SNS (Pin 14): Output voltage sense pin. Connect this pin to the output voltage as close to the load as possible.

Exposed Pad: Connect to ground.

Ordering Information

Order Number	Frequency	Voltage Option	Package Type	Package Drawing	Supplied As
LM2852YMXA-0.8	500kHz	0.8	TSSOP-14 exposed pad	MXA14A	94 Units, Rail
LM2852YMXAX-0.8					2500 Units, Tape and Reel
LM2852YMXA-1.0		1.0			94 Units, Rail
LM2852YMXAX-1.0					2500 Units, Tape and Reel
LM2852YMXA-1.2		1.2			94 Units, Rail
LM2852YMXAX-1.2					2500 Units, Tape and Reel
LM2852YMXA-1.5		1.5			94 Units, Rail
LM2852YMXAX-1.5					2500 Units, Tape and Reel
LM2852YMXA-1.8		1.8			94 Units, Rail
LM2852YMXAX-1.8					2500 Units, Tape and Reel
LM2852YMXA-2.5		2.5			94 Units, Rail
LM2852YMXAX-2.5					2500 Units, Tape and Reel
LM2852YMXA-3.0		3.0			94 Units, Rail
LM2852YMXAX-3.0					2500 Units, Tape and Reel
LM2852YMXA-3.3		3.3			94 Units, Rail
LM2852YMXAX-3.3					2500 Units, Tape and Reel
LM2852XMXA-0.8	1500kHz	0.8	TSSOP-14 exposed pad	MXA14A	94 Units, Rail
LM2852XMXAX-0.8					2500 Units, Tape and Reel
LM2852XMXA-1.0		1.0			94 Units, Rail
LM2852XMXAX-1.0					2500 Units, Tape and Reel
LM2852XMXA-1.2		1.2			94 Units, Rail
LM2852XMXAX-1.2					2500 Units, Tape and Reel
LM2852XMXA-1.5		1.5			94 Units, Rail
LM2852XMXAX-1.5					2500 Units, Tape and Reel
LM2852XMXA-1.8		1.8			94 Units, Rail
LM2852XMXAX-1.8					2500 Units, Tape and Reel
LM2852XMXA-2.5		2.5			94 Units, Rail
LM2852XMXAX-2.5					2500 Units, Tape and Reel
LM2852XMXA-3.0		3.0			94 Units, Rail
LM2852XMXAX-3.0					2500 Units, Tape and Reel
LM2852XMXA-3.3		3.3			94 Units, Rail
LM2852XMXAX-3.3					2500 Units, Tape and Reel

Note: Contact factory for other voltage options.

Absolute Maximum Ratings (Note 1)

If Military/Aerospace specified devices are required, please contact the National Semiconductor Sales Office/Distributors for availability and specifications.

PVIN, AVIN, EN, SNS	-0.3V to 6.5V
ESD Susceptibility (Note 2)	2kV
Power Dissipation	Internally Limited
Storage Temperature Range	-65°C to +150°C
Maximum Junction Temp.	150°C
14-Pin Exposed Pad TSSOP	
Package	220°C
Infrared (15 sec)	215°C
Vapor Phase (60 sec)	260°C
Soldering (10 sec)	

Operating Ratings

PVIN to GND	1.5V to 5.5V
AVIN to GND	2.85V to 5.5V
Junction Temperature	-40°C to +125°C
θ_{JA}	38°C/W

Electrical Characteristics

AVIN = PVIN = 5V unless otherwise indicated under the **Conditions** column.

Limits in standard type are for $T_J = 25^\circ\text{C}$ only; limits in **boldface type** apply over the junction temperature (T_J) range of -40°C to $+125^\circ\text{C}$. Minimum and Maximum limits are guaranteed through test, design, or statistical correlation. Typical values represent the most likely parametric norm at $T_J = 25^\circ\text{C}$, and are provided for reference purposes only.

Symbol	Parameter	Conditions	Min	Typ	Max	Units
SYSTEM PARAMETERS						
V_{OUT}	Voltage Tolerance ³	$V_{OUT} = 0.8\text{V}$ option	0.782		0.818	V
		$V_{OUT} = 1.0\text{V}$ option	0.9775		1.0225	
		$V_{OUT} = 1.2\text{V}$ option	1.1730		1.2270	
		$V_{OUT} = 1.5\text{V}$ option	1.4663		1.5337	
		$V_{OUT} = 1.8\text{V}$ option	1.7595		1.8405	
		$V_{OUT} = 2.5\text{V}$ option	2.4437		2.5563	
		$V_{OUT} = 3.0\text{V}$ option	2.9325		3.0675	
		$V_{OUT} = 3.3\text{V}$ option	3.2257		3.3743	
$\Delta V_{OUT}/\Delta AVIN$	Line Regulation ³	$V_{OUT} = 0.8\text{V}, 1.0\text{V}, 1.2\text{V}, 1.5\text{V}, 1.8\text{V}$ or 2.5V $2.85\text{V} \leq AVIN \leq 5.5\text{V}$		0.2	0.6	%
		$V_{OUT} = 3.3\text{V}$ $3.5\text{V} \leq AVIN \leq 5.5\text{V}$		0.2	0.6	%
$\Delta V_{OUT}/\Delta I_O$	Load Regulation	Normal operation		8		mV/A
V_{ON}	UVLO Threshold (AVIN)	Rising		2.47	2.85	V
		Falling Hysteresis	85	150	210	mV
$r_{DS(on)-P}$	PFET On Resistance	$I_{sw} = 2\text{A}$		75	140	m Ω
$r_{DS(on)-N}$	NFET On Resistance	$I_{sw} = 2\text{A}$		55	120	m Ω
R_{SS}	Soft-start resistance			400		k Ω
I_{CL}	Peak Current Limit Threshold	LM2852X	2.75	4	4.95	A
		LM2852Y	2.25	3	3.65	
I_Q	Operating Current	Non-switching		0.85	2	mA
I_{SD}	Shutdown Quiescent Current	EN = 0V		10	25	μA
R_{SNS}	Sense pin resistance			400		k Ω
PWM						
f_{osc}	LM2852X	1500kHz option.	1050	1500	1825	kHz
	LM2852Y	500kHz option.	325	500	625	kHz

Electrical Characteristics AVIN = PVIN = 5V unless otherwise indicated under the **Conditions** column.

Limits in standard type are for $T_J = 25^\circ\text{C}$ only; limits in **boldface type** apply over the junction temperature (T_J) range of -40°C to $+125^\circ\text{C}$. Minimum and Maximum limits are guaranteed through test, design, or statistical correlation. Typical values represent the most likely parametric norm at $T_J = 25^\circ\text{C}$, and are provided for reference purposes only. (Continued)

Symbol	Parameter	Conditions	Min	Typ	Max	Units
D_{range}	Duty Cycle Range		0		100	%
ENABLE CONTROL⁴						
V_{IH}	EN Pin Minimum High Input		75			% of AVIN
V_{IL}	EN Pin Maximum Low Input				25	% of AVIN
I_{EN}	EN Pin Pullup Current	EN = 0V		1.2		μA
THERMAL CONTROLS						
T_{SD}	T_J for Thermal Shutdown			165		$^\circ\text{C}$
$T_{\text{SD-HYS}}$	Hysteresis for Thermal Shutdown			10		$^\circ\text{C}$

Note 1: Absolute maximum ratings indicate limits beyond which damage to the device may occur. Operating Range indicates conditions for which the device is intended to be functional, but does not guarantee specific performance limits. For guaranteed specifications and test conditions, see the Electrical Characteristics.

Note 2: Human body model: 1.5k Ω in series with 100pF. SW and PVIN pins are derated to 1.5kV

Note 3: V_{OUT} measured in a non-switching, closed-loop configuration at the SNS pin.

Note 4: The enable pin is internally pulled up, so the LM2852 is automatically enabled unless an external enable voltage is applied.

LM2852Y Typical Performance Characteristics (500kHz)

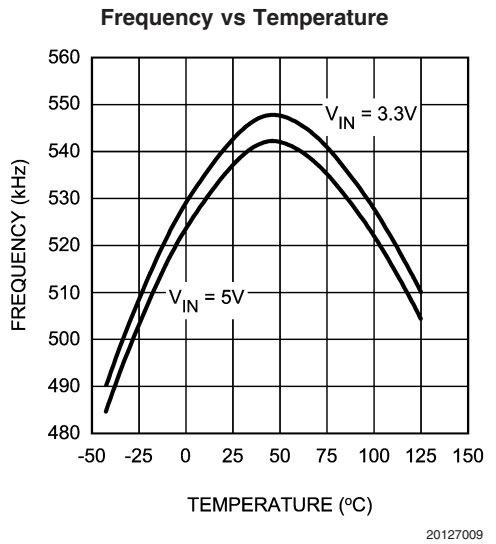
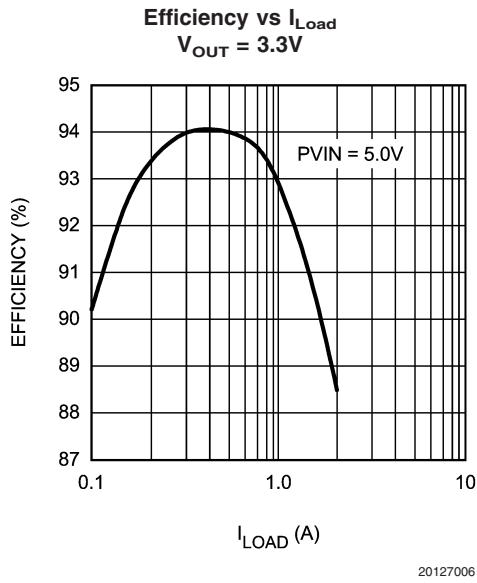
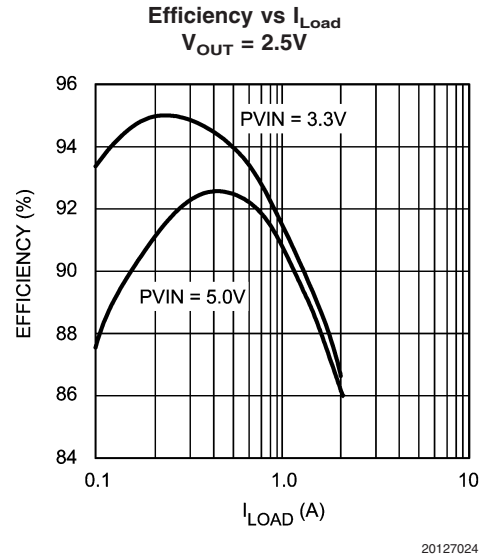
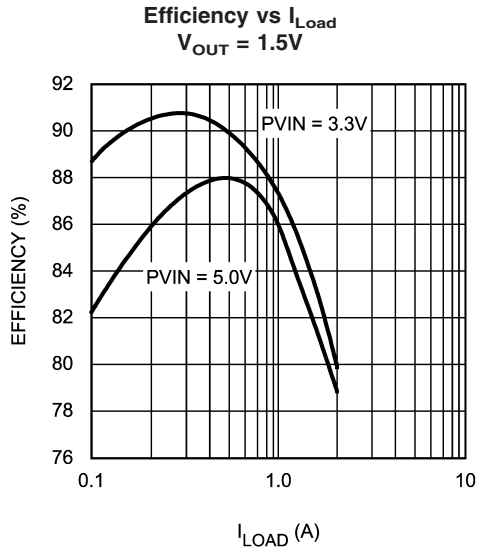

LM2852X Typical Performance Characteristics (1500kHz)

Efficiency vs I_{Load}
 $V_{OUT} = 1.5V$

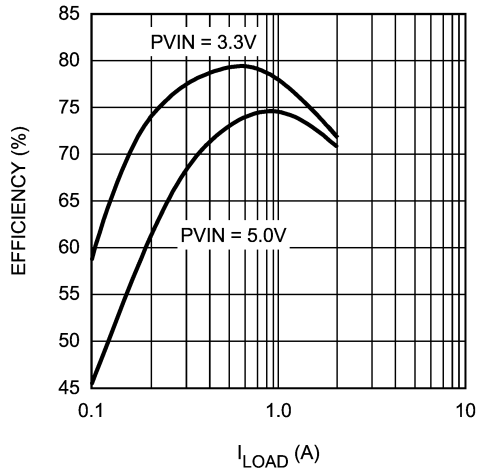

20127025

Efficiency vs I_{Load}
 $V_{OUT} = 2.5V$

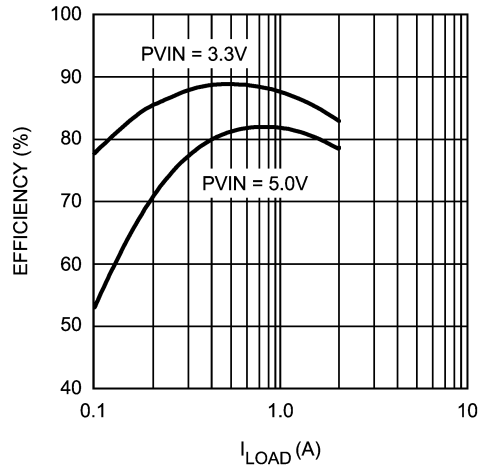

20127026

Efficiency vs I_{Load}
 $V_{OUT} = 3.3V$

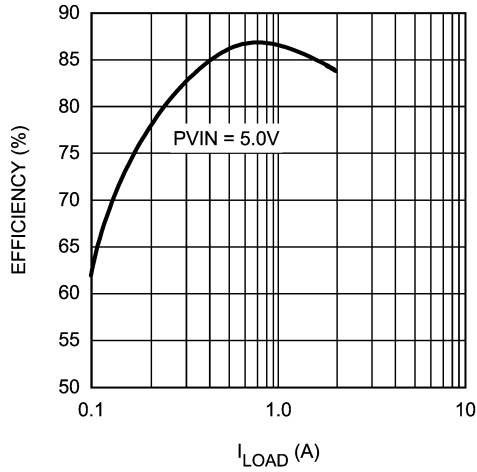

20127027

Frequency vs Temperature

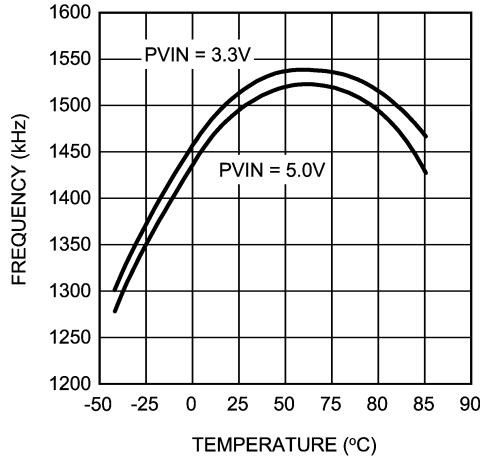

20127028

LM2852 Typical Performance Characteristics (Both Y and X Versions)

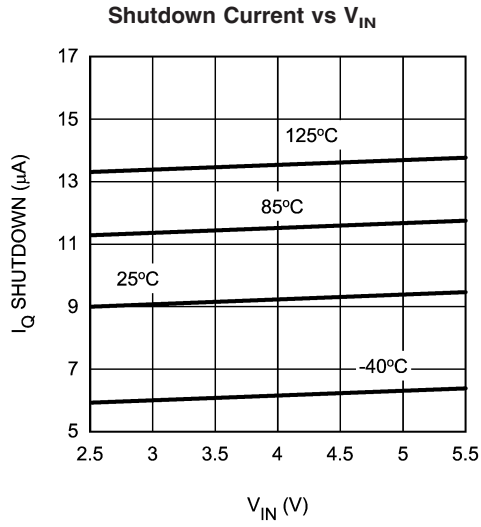

20127008

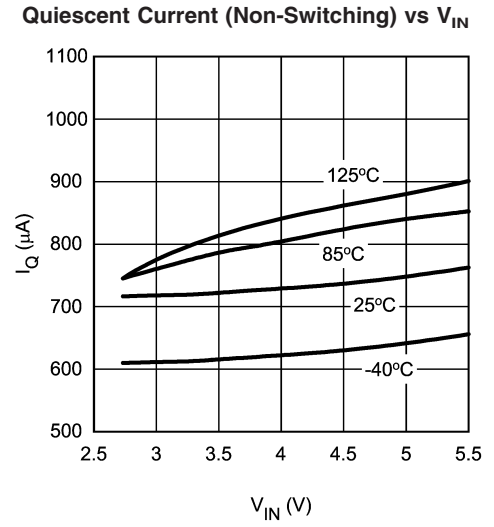

20127007

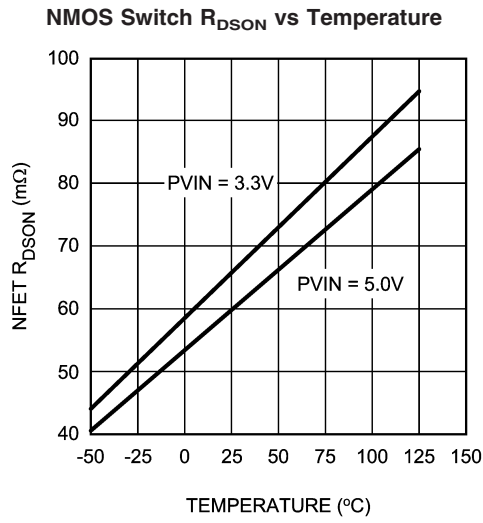

20127010

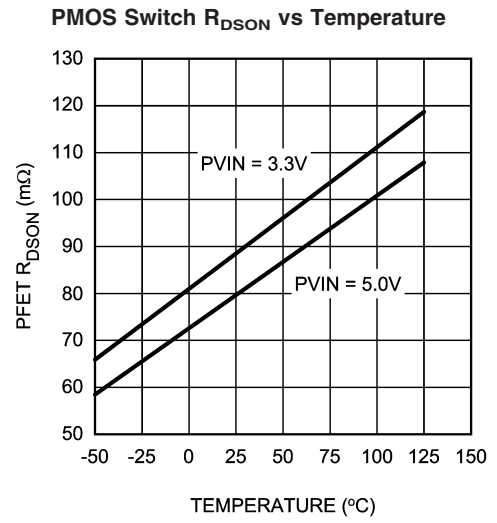

20127011

Applications Information (Continued)

falls to a low voltage. During this time, the soft-start voltage is forced to track the output so that once the short is removed, the LM2852 can restart gracefully from whatever voltage the output reached during the short circuit event. The range of soft-start capacitors is therefore restricted to values 1nF to 50nF.

COMPENSATION

The LM2852 provides a highly integrated solution to power supply design. The compensation of the LM2852, which is

type-three, is included on-chip. The benefit to integrated compensation is straightforward, simple power supply design. Since the output filter capacitor and inductor values impact the compensation of the control loop, the range of L, C and C_{ESR} values is restricted in order to ensure stability.

OUTPUT FILTER VALUES

Table 1 details the recommended inductor and capacitor ranges for the LM2852 that are suggested for various typical output voltages. Values slightly different than those recommended may be used, however the phase margin of the power supply may be degraded.

TABLE 1. Output Filter Values

Frequency Option	V_{OUT} (V)	PV_{IN} (V)	L (μ H)		C (μ F)		C_{ESR} (m Ω)	
			Min	Max	Min	Max	Min	Max
LM2852Y (500kHz)	0.8	3.3	10	15	100	220	70	200
	0.8	5.0	10	15	100	120	70	200
	1.0	3.3	10	15	100	180	70	200
	1.0	5.0	10	15	100	180	70	200
	1.2	3.3	10	15	100	180	70	200
	1.2	5.0	15	22	100	120	70	200
	1.5	3.3	10	15	100	120	70	200
	1.5	5.0	22	22	100	120	70	200
	1.8	3.3	10	15	100	120	100	200
	1.8	5.0	22	33	100	120	100	200
	2.5	3.3	6.8	10	68	120	95	275
	2.5	5.0	15	22	68	120	95	275
	3.3	5.0	15	22	68	100	100	275
LM2852X (1500kHz)	0.8	3.3	1	10	10	10	100	200
	0.8	5.0						
	1.0	3.3						
	1.0	5.0						
	1.2	3.3						
	1.2	5.0						
	1.5	3.3						
	1.5	5.0						
	1.8	3.3						
	1.8	5.0						
	2.5	3.3						
	2.5	5.0						
	3.3	5.0						

The 1500kHz version is designed for ceramic output capacitors which typically have very low ESR (<10m Ω .)

Applications Information (Continued)

CHOOSING AN INDUCTANCE VALUE

The current ripple present in the output filter inductor is determined by the input voltage, output voltage, switching frequency and inductance according to the following equation:

$$\Delta I_L = \frac{D \times (V_{IN} - V_{OUT})}{f \times L}$$

where ΔI_L is the peak-to-peak current ripple, D is the duty cycle V_{OUT}/V_{IN} , V_{IN} is the input voltage applied to the PVIN pin, V_{OUT} is the output voltage of the switcher, f is the switching frequency and L is the inductance of the output filter inductor. Knowing the current ripple is important for inductor selection since the peak current through the inductor is the load current plus one half the ripple current. Care must be taken to ensure the peak inductor current does not reach a level high enough to trip the current limit circuitry of the LM2852.

As an example, consider a 5V to 1.2V conversion and a 500kHz switching frequency. According to *Table 1*, a 15 μ H inductor may be used. Calculating the expected peak-to-peak ripple,

$$\Delta I_L = \frac{\frac{1.2V}{5V} \times (5V - 1.2V)}{500 \text{ kHz} \times 15 \mu\text{H}} = 121.6 \text{ mA}$$

The maximum inductor current for a 2A load would therefore be 2A plus 60.8 mA, 2.0608A. As shown in the ripple equation, the current ripple is inversely proportional to inductance.

OUTPUT FILTER INDUCTORS

Once the inductance value is chosen, the key parameter for selecting the output filter inductor is its saturation current (I_{sat}) specification. Typically I_{sat} is given by the manufacturer as the current at which the inductance of the coil falls to a certain percentage of the nominal inductance. The I_{sat} of an inductor used in an application should be greater than the maximum expected inductor current to avoid saturation. Below is a table of inductors that may be suitable in LM2852 applications.

TABLE 2. LM2852 Output Filter Inductors

Inductance (μ H)	Part Number	Vendor
1	DO1608C-102	Coilcraft
1	DO1813P-102HC	Coilcraft
6.8	DO3316P-682	Coilcraft
7	MSS1038-702NBC	Coilcraft
10	DO3316P-103	Coilcraft
10	MSS1038-103NBC	Coilcraft
12	MSS1038-123NBC	Coilcraft
15	D03316P-153	Coilcraft
15	MSS1038-153NBC	Coilcraft
18	MSS1038-183NBC	Coilcraft
22	DO3316P-223	Coilcraft
22	MSS1038-223NBC	Coilcraft
22	DO3340P-223	Coilcraft
27	MSS1038-273NBC	Coilcraft
33	MSS1038-333NBC	Coilcraft
33	DO3340P-333	Coilcraft

Applications Information (Continued)

Table 1. Below are some examples of capacitors that can typically be used in an LM2852 application.

OUTPUT FILTER CAPACITORS

The capacitors that may be used in the output filter with the LM2852 are limited in value and ESR range according to

TABLE 3. LM2852 Output Filter Capacitors

Capacitance (μF)	Part Number	Chemistry	Vendor
10	GRM31MR61A106KE19	Ceramic	Murata
10	GRM32DR61E106K	Ceramic	Murata
68	595D686X_010C2T	Tantalum	Vishay - Sprague
68	595D686X_016D2T	Tantalum	Vishay - Sprague
100	595D107X_6R3C2T	Tantalum	Vishay - Sprague
100	595D107X_016D2T	Tantalum	Vishay - Sprague
100	NOSC107M004R0150	Niobium Oxide	AVX
100	NOSD107M006R0100	Niobium Oxide	AVX
120	595D127X_004C2T	Tantalum	Vishay - Sprague
120	595D127X_010D2T	Tantalum	Vishay - Sprague
150	595D157X_004C2T	Tantalum	Vishay - Sprague
150	595D157X_016D2T	Tantalum	Vishay - Sprague
150	NOSC157M004R0150	Niobium Oxide	AVX
150	NOSD157M006R0100	Niobium Oxide	AVX
220	595D227X_004D2T	Tantalum	Vishay - Sprague
220	NOSD227M004R0100	Niobium Oxide	AVX
220	NOSE227M006R0100	Niobium Oxide	AVX

SPLIT-RAIL OPERATION

The LM2852 can be powered using two separate voltages for AVIN and PVIN. AVIN is the supply for the control logic; PVIN is the supply for the power FETs. The output filter

components need to be chosen based on the value of PVIN. For PVIN levels lower than 3.3V, use output filter component values recommended for 3.3V. PVIN must always be equal to or less than AVIN.

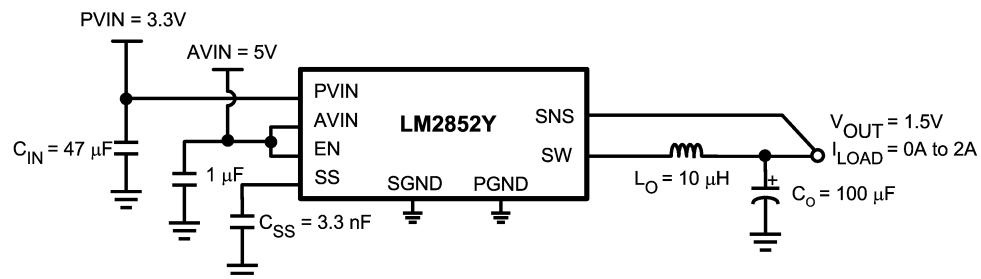

20127014

SWITCH NODE PROTECTION

The LM2852 includes protection circuitry that monitors the voltage on the switch pin. Under certain conditions, switching is disabled in order to protect the switching devices. One result of the protection circuitry may be observed when

power to the LM2852 is applied with no or light load on the output. The output regulates to the rated voltage, but no switching may be observed. As soon as the output is loaded, the LM2852 begins normal switching operation.

Applications Information (Continued)

LAYOUT HINTS

These are several guidelines to follow while designing the PCB layout for an LM2852 application.

1. The input bulk capacitor, C_{IN} , should be placed very close to the PVIN pin to keep the resistance as low as possible between the capacitor and the pin. High current levels will be present in this connection.
2. All ground connections must be tied together. Use a broad ground plane, for example a completely filled back plane, to establish the lowest resistance possible between all ground connections.
3. The sense pin connection should be made as close to the load as possible so that the voltage at the load is the

expected regulated value. The sense line should not run too close to nodes with high EMI (such as the switch node) to minimize interference.

4. The switch node connections should be low resistance to reduce power losses. Low resistance means the trace between the switch pin and the inductor should be wide. However, the area of the switch node should not be too large since EMI increases with greater area. So connect the inductor to the switch pin with a short, but wide trace. Other high current connections in the application such as PVIN and V_{OUT} assume the same trade off between low resistance and EMI.
5. Allow area under the chip to solder the entire exposed die attach pad to ground for improved thermal and electrical performance.

LM2852 Example Circuit Schematic

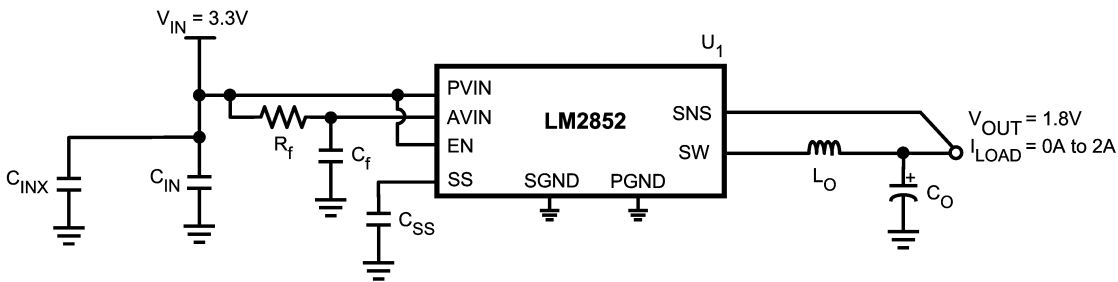

20127020

FIGURE 1.

Bill of Materials for 500kHz (LM2852Y) 3.3V_{IN} to 1.8 V_{OUT} Conversion

ID	Part Number	Type	Size	Parameters	Qty	Vendor
U ₁	LM2852YMXA-1.8	2A Buck	ETSSOP-14		1	NSC
L _O	DO3316P-153	Inductor		15 μH	1	Coilcraft
C _O *	595D107X_6R3C2T	Capacitor	Case Code "C"	100 μF ±20%	1	Vishay-Sprague
C _{IN}	GRM32ER60J476ME20B	Capacitor	1210	47μF/X5R/6.3V	1	Murata
C _{INX}	GRM21BR71C105KA01B	Capacitor	0805	1μF/X7R/16V	1	Murata
C _{SS}	VJ0805Y272KXXA	Capacitor	0805	2.7nF ±10%	1	Vishay-Vitramon
R _f	CRCW060310R0F	Resistor	0603	10Ω ±10%	1	Vishay-Dale
C _f	GRM21BR71C105KA01B	Capacitor	0805	1μF/X7R/16V	1	Murata

* If a "non-tantalum" solution is desired use an NOSC107M004R0150, 100 μF capacitor from AVX for C_O.

Bill of Materials for 1500kHz (LM2852X) 3.3V to 1.8V Conversion

ID	Part Number	Type	Size	Parameters	Qty	Vendor
U ₁	LM2852XMXA-1.8	2A Buck	ETSSOP-14		1	NSC
L _O	DO1813P-102HC	Inductor		1 μH	1	Coilcraft
C _O	GRM32DR61E106K	Capacitor	1210	10 μF/X5R/25V	1	Murata
C _{IN}	GRM32ER60J476ME20B	Capacitor	1210	47μF/X5R/6.3V	1	Murata
C _{INX}	GRM21BR71C105KA01B	Capacitor	0805	1μF/X7R/16V	1	Murata
C _{SS}	VJ0805Y272KXXA	Capacitor	0805	2.7nF ±10%	1	Vishay-Vitramon
R _f	CRCW060310R0F	Resistor	0603	10Ω ±10%	1	Vishay-Dale
C _f	GRM21BR71C105KA01B	Capacitor	0805	1μF/X7R/16V	1	Murata

Physical Dimensions inches (millimeters) unless otherwise noted

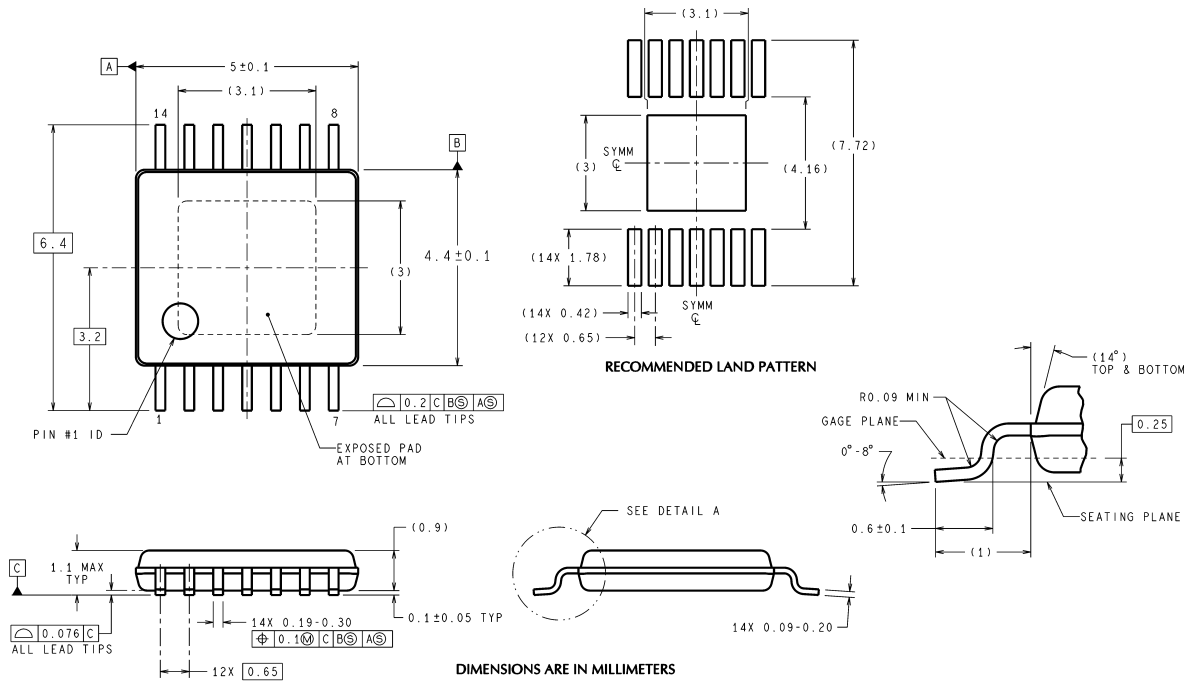

14-Lead ETSSOP Package
NS Package Number MXA14A

MXA14A (Rev A)

National does not assume any responsibility for use of any circuitry described, no circuit patent licenses are implied and National reserves the right at any time without notice to change said circuitry and specifications.

For the most current product information visit us at www.national.com.

LIFE SUPPORT POLICY

NATIONAL'S PRODUCTS ARE NOT AUTHORIZED FOR USE AS CRITICAL COMPONENTS IN LIFE SUPPORT DEVICES OR SYSTEMS WITHOUT THE EXPRESS WRITTEN APPROVAL OF THE PRESIDENT AND GENERAL COUNSEL OF NATIONAL SEMICONDUCTOR CORPORATION. As used herein:

1. Life support devices or systems are devices or systems which, (a) are intended for surgical implant into the body, or (b) support or sustain life, and whose failure to perform when properly used in accordance with instructions for use provided in the labeling, can be reasonably expected to result in a significant injury to the user.
2. A critical component is any component of a life support device or system whose failure to perform can be reasonably expected to cause the failure of the life support device or system, or to affect its safety or effectiveness.

BANNED SUBSTANCE COMPLIANCE

National Semiconductor follows the provisions of the Product Stewardship Guide for Customers (CSP-9-111C2) and Banned Substances and Materials of Interest Specification (CSP-9-111S2) for regulatory environmental compliance. Details may be found at: www.national.com/quality/green.

Lead free products are RoHS compliant.



National Semiconductor
Americas Customer
Support Center
Email: new.feedback@nsc.com
Tel: 1-800-272-9959

National Semiconductor
Europe Customer Support Center
Fax: +49 (0) 180-530 85 86
Email: europe.support@nsc.com
Deutsch Tel: +49 (0) 69 9508 6208
English Tel: +44 (0) 870 24 0 2171
Français Tel: +33 (0) 1 41 91 8790

National Semiconductor
Asia Pacific Customer
Support Center
Email: ap.support@nsc.com

National Semiconductor
Japan Customer Support Center
Fax: 81-3-5639-7507
Email: jpn.feedback@nsc.com
Tel: 81-3-5639-7560