

# Notice for TAIYO YUDEN products

Please read this notice before using the TAIYO YUDEN products.

## REMINDERS

- Product information in this catalog is as of October 2009. All of the contents specified herein are subject to change without notice due to technical improvements, etc. Therefore, please check for the latest information carefully before practical application or usage of the Products.

Please note that Taiyo Yuden Co., Ltd. shall not be responsible for any defects in products or equipment incorporating such products, which are caused under the conditions other than those specified in this catalog or individual specification.

- Please contact Taiyo Yuden Co., Ltd. for further details of product specifications as the individual specification is available.
- Please conduct validation and verification of products in actual condition of mounting and operating environment before commercial shipment of the equipment.

- All electronic components or functional modules listed in this catalog are developed, designed and intended for use in general electronics equipment.(for AV, office automation, household, office supply, information service, telecommunications, (such as mobile phone or PC) etc.). Before incorporating the components or devices into any equipment in the field such as transportation,( automotive control, train control, ship control), transportation signal, disaster prevention, medical, public information network (telephone exchange, base station) etc. which may have direct influence to harm or injure a human body, please contact Taiyo Yuden Co., Ltd. for more detail in advance. Do not incorporate the products into any equipment in fields such as aerospace, aviation, nuclear control, submarine system, military, etc. where higher safety and reliability are especially required.

In addition, even electronic components or functional modules that are used for the general electronic equipment, if the equipment or the electric circuit require high safety or reliability function or performances, a sufficient reliability evaluation check for safety shall be performed before commercial shipment and moreover, due consideration to install a protective circuit is strongly recommended at customer's design stage.

- The contents of this catalog are applicable to the products which are purchased from our sales offices or distributors (so called "TAIYO YUDEN' s official sales channel"). It is only applicable to the products purchased from any of TAIYO YUDEN' s official sales channel.

- Please note that Taiyo Yuden Co., Ltd. shall have no responsibility for any controversies or disputes that may occur in connection with a third party's intellectual property rights and other related rights arising from your usage of products in this catalog. Taiyo Yuden Co., Ltd. grants no license for such rights.

- Caution for export

Certain items in this catalog may require specific procedures for export according to "Foreign Exchange and Foreign Trade Control Law" of Japan, "U.S. Export Administration Regulations", and other applicable regulations. Should you have any question or inquiry on this matter, please contact our sales staff. Should you have any question or inquiry on this matter, please contact our sales staff.

# WOUND CHIP INDUCTORS (LB SERIES)

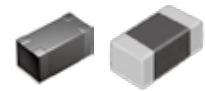

REFLOW

## FEATURES

Wound Chip Inductors cover customers' wide range module designs by wide-line-up shape, standard, low Rdc, and high electric current series.

- LB/LBR Series : Super low Rdc and high Idc characteristics.
- LB3218 Series : This series is downsized from 3225 size. Land pattern can be used by 3225 size.
- LBMF1608  
The best efficiency design is achieved by adopting bottom-surface electrode structure. Because of 1608 shape, it can be high-density mounting.

## APPLICATIONS

- DSC/DVC/HDD, LCD, portable telephones, game equipments.  
Various audio-visual equipments, various communication equipments, etc.

## ORDERING CODE

L B △ 2 0 1 2 T 1 0 0 △ △ △ △ △

**1 Type**

LB Wound chip inductor

**2 Shape**

△	Standard products
C	High current
R	Low Rdc
MF	Bottom-surface electrode

**3 External Dimensions (mm)**

1608 (0603)	1.6×0.8
2012 (0805)	2.0×1.25
2016 (0806)	2.0×1.6
2518 (1007)	2.5×1.8
3218 (1207)	3.2×1.8
3225 (1210)	3.2×1.5

**4 Packaging**

T Tape & Reel

**5 Nominal Inductance (μH)**

example	
1R0	1
100	10
101	100

※R=decimal point

**6 Inductance Tolerances (%)**

K	±10
M	±20

**7 Special code**

△	Standard products
R	Low Rdc type

**8 Internal code**

△△△	Standard Products
-----	-------------------

△=Blank space

## EXTERNAL DIMENSIONS/STANDARD QUANTITY

### EXTERNAL DIMENSIONS

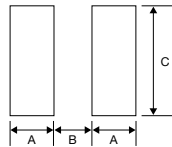
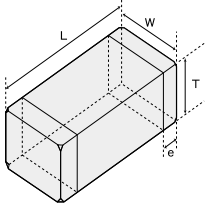

Unit : mm

TYPE	A	B	C
1608	0.55	0.7	1.0
MF1608	0.55	0.8	0.9
2012	0.7	0.8	1.45
2016	0.7	0.8	1.8
2518	0.8	1.2	2.0
3218	1.0	1.6	2.0
3225	1.0	1.6	2.0

- Surface Mounting
- Mounting and soldering conditions should be checked beforehand.
  - Applicable soldering process to those products is reflow soldering only.
  - Recommended Land Patterns

Type	L	W	T	e	Standard Quantity [pcs]	
					Paper Tape	Embossed Tape
LBC3225	3.2±0.2 (0.128±0.008)	2.5±0.2 (0.098±0.008)	2.5±0.2 (0.098±0.008)	0.6±0.3 (0.024±0.012)	—	1000
LB3218	3.2±0.2 (0.128±0.008)	1.8±0.2 (0.071±0.008)	1.8±0.2 (0.071±0.008)	0.6±0.2 (0.024±0.008)	—	2000
LB2518 LBC2518 LBR2518	2.5±0.2 (0.098±0.008)	1.8±0.2 (0.071±0.008)	1.8±0.2 (0.071±0.008)	0.5±0.2 (0.020±0.008)	—	2000
LB2016 LBC2016	2.0±0.2 (0.079±0.008)	1.6±0.2 (0.063±0.008)	1.6±0.2 (0.063±0.008)	0.5±0.2 (0.020±0.008)	—	2000
LB2012 LBC2012 LBR2012	2.0±0.2 (0.079±0.008)	1.25±0.2 (0.049±0.008)	1.25±0.2 (0.049±0.008)	0.5±0.2 (0.020±0.008)	—	2000
LB1608	1.6±0.1 (0.063±0.004)	0.8±0.1 (0.031±0.004)	0.8±0.1 (0.031±0.004)	0.35±0.15 (0.014±0.006)	4000	—
LBMF1608	1.6±0.2 (0.063±0.008)	0.8±0.2 (0.031±0.008)	0.8±0.2 (0.031±0.008)	0.45±0.15 (0.016±0.006)	—	3000

Unit : mm (inch)

## AVAILABLE CAPACITANCE RANGE

Range	Type	LB3218	LB2518	LB2016	LB2012	LB1608	LBC3225	LBC2518	LBC2016	LBC2012	LBR2518	LBR2012	LBMF1608
Inductance [μH]	1	Imax[mA] Rdc±30%[Ω] 1075 1μH 0.06	Imax[mA] Rdc±30%[Ω] 665 1μH 0.06	Imax[mA] Rdc±30%[Ω] 490 1μH 0.09	Imax[mA] Rdc±30%[Ω] 405 1μH 0.15	Imax[mA] Rdc±30%[Ω] 160 1μH 0.17	Imax[mA] Rdc±30%[Ω] 1100 1μH 0.055	Imax[mA] Rdc±30%[Ω] 775 1μH 0.08	Imax[mA] Rdc±30%[Ω] 690 1μH 0.1	Imax[mA] Rdc±30%[Ω] 620 1μH 0.19	Imax[mA] Rdc±30%[Ω] 960 1μH 0.045	Imax[mA] Rdc±30%[Ω] 400 1μH 0.07	Imax[mA] Rdc±30%[Ω] 230 1μH 0.09
	10	340 0.25	165 0.25	155 0.5	120 0.7	70 0.55 60 0.7	540 0.133	375 0.36	245 0.82	200 1.2	235 0.19	150 0.36	80 0.36
	100	140 2.40	60 2.1	40 4.5	45 7.0	10μH	150 1.4	125 3.70	75 8.0	90 5.8 47μH	80 1.89	50 4.0	35 2.5 47μH
	1000	40 27 1000μH	15 24 1000μH	100μH	100μH		100μH	45 28.0 680μH	100μH		100μH	100μH	

\* This catalog contains the typical specification only due to the limitation of space. When you consider purchase of our products, please check our specification. For details of each product (characteristics graph, reliability information, precautions for use, and so on), see our Web site (<http://www.ty-top.com/>) or CD catalogs.

**PART NUMBERS**

● **LB1608 TYPE**

Ordering code	EHS (Environmental Hazardous Substances)	Inductance [ $\mu$ H]	Inductance Tolerance	Self-resonant frequency (MHz) min.	DC Resistance [ $\Omega$ ] ( $\pm 30\%$ )	Rated current (mA) max.	Measuring frequency (MHz)
LB 1608T1R0M	RoHS	1.0	$\pm 20\%$	100	0.17	160	7.96
LB 1608T2R2M	RoHS	2.2		80	0.33	115	
LB 1608T4R7M	RoHS	4.7		45	0.55	70	
LB 1608T8R2M	RoHS	8.2		32	0.70	60	2.52
LB 1608T100M	RoHS	10		32	0.70	60	

● **LB2012 TYPE**

Ordering code	EHS (Environmental Hazardous Substances)	Inductance [ $\mu$ H]	Inductance Tolerance	Self-resonant frequency (MHz) min.	DC Resistance [ $\Omega$ ] ( $\pm 30\%$ )	Rated current (mA) max.	Measuring frequency (MHz)	
LB 2012T1R0M	RoHS	1.0	$\pm 20\%$	100	0.15	405	7.96	
LB 2012T2R2M	RoHS	2.2		80	0.23	260		
LB 2012T3R3M	RoHS	3.3		55	0.30	235		
LB 2012T4R7M	RoHS	4.7		45	0.40	190		
LB 2012T6R8M	RoHS	6.8		38	0.47	135		
LB 2012T100□	RoHS	10	$\pm 10\%$ $\pm 20\%$	32	0.70	120	2.52	
LB 2012T100□R	RoHS	10		32	0.50	120		
LB 2012T150□	RoHS	15		28	1.3	100		
LB 2012T220□	RoHS	22		16	1.7	80		
LB 2012T470□	RoHS	47		11	3.7	60		
LB 2012T680□	RoHS	68		10	6.0	50		
LB 2012T101□	RoHS	100		8	7.0	45		0.796

● **LB2016 TYPE**

Ordering code	EHS (Environmental Hazardous Substances)	Inductance [ $\mu$ H]	Inductance Tolerance	Self-resonant frequency (MHz) min.	DC Resistance [ $\Omega$ ] ( $\pm 30\%$ )	Rated current (mA) max.	Measuring frequency (MHz)
LB 2016T1R0M	RoHS	1.0	$\pm 20\%$	100	0.09	490	7.96
LB 2016T1R5M	RoHS	1.5		80	0.11	380	
LB 2016T2R2M	RoHS	2.2		70	0.13	375	
LB 2016T3R3M	RoHS	3.3		55	0.20	285	
LB 2016T4R7M	RoHS	4.7		45	0.25	225	
LB 2016T6R8M	RoHS	6.8		38	0.35	200	
LB 2016T100□	RoHS	10	$\pm 10\%$ $\pm 20\%$	32	0.50	155	2.52
LB 2016T150□	RoHS	15		28	0.70	130	
LB 2016T220□	RoHS	22		16	1.0	105	
LB 2016T330□	RoHS	33		14	1.7	85	
LB 2016T470□	RoHS	47		11	2.4	70	
LB 2016T680□	RoHS	68		10	3.0	55	
LB 2016T101□	RoHS	100		8	4.5	40	

● **LB2518 TYPE**

Ordering code	EHS (Environmental Hazardous Substances)	Inductance [ $\mu$ H]	Inductance Tolerance	Self-resonant frequency (MHz) min.	DC Resistance [ $\Omega$ ] ( $\pm 30\%$ )	Rated current (mA) max.	Measuring frequency (MHz)
LB 2518T1R0M	RoHS	1.0	$\pm 20\%$	100	0.06	665	7.96
LB 2518T1R5M	RoHS	1.5		80	0.07	405	
LB 2518T2R2M	RoHS	2.2		68	0.09	340	
LB 2518T3R3M	RoHS	3.3		54	0.11	280	
LB 2518T4R7M	RoHS	4.7		46	0.13	240	
LB 2518T4R7MR	RoHS	4.7		46	0.10	235	
LB 2518T6R8M	RoHS	6.8		38	0.15	195	
LB 2518T100□	RoHS	10		30	0.25	165	
LB 2518T150□	RoHS	15		23	0.32	145	
LB 2518T220□	RoHS	22		19	0.50	115	
LB 2518T330□	RoHS	33	15	0.70	95	2.52	
LB 2518T470□	RoHS	47	12	0.95	85		
LB 2518T680□	RoHS	68	9.5	1.5	70	$\pm 10\%$ $\pm 20\%$	
LB 2518T101□	RoHS	100	9.0	2.1	60		
LB 2518T151□	RoHS	150	7.0	3.2	45		
LB 2518T221□	RoHS	220	5.5	4.5	40		
LB 2518T331□	RoHS	330	4.5	7.0	30		
LB 2518T471□	RoHS	470	3.5	10	25		
LB 2518T681□	RoHS	680	3.0	17	20		
LB 2518T102□	RoHS	1000	2.4	24	15		0.252

□ Please specify the Inductance tolerance code (K or M)

\* This catalog contains the typical specification only due to the limitation of space. When you consider purchase of our products, please check our specification. For details of each product (characteristics graph, reliability information, precautions for use, and so on), see our Web site (<http://www.ty-top.com/>) or CD catalogs.

**PART NUMBERS**

● **LB3218 TYPE**

Ordering code		EHS (Environmental Hazardous Substances)	Inductance [μH]	Inductance Tolerance	Self-resonant frequency [MHz] min.	DC Resistance [Ω] (±30%)	Rated current [mA] max.	Measuring frequency [MHz]
LB 3218T1R0M		RoHS	1.0	±20%	100	0.06	1075	7.96
LB 3218T1R5M		RoHS	1.5		80	0.07	860	
LB 3218T2R2M		RoHS	2.2		68	0.09	775	
LB 3218T3R3M		RoHS	3.3		54	0.11	560	
LB 3218T4R7M		RoHS	4.7		41	0.13	550	
LB 3218T6R8M		RoHS	6.8		40	0.17	380	
LB 3218T100□		RoHS	10	±10% ±20%	30	0.25	340	2.52
LB 3218T150□		RoHS	15		25	0.32	300	
LB 3218T220□		RoHS	22		19	0.49	255	
LB 3218T330□		RoHS	33		15	0.75	215	
LB 3218T470□		RoHS	47		12	0.92	205	
LB 3218T680□		RoHS	68		11	1.49	145	
LB 3218T101□		RoHS	100		8.0	2.4	140	0.796
LB 3218T151□		RoHS	150		7.0	3.2	105	
LB 3218T221□		RoHS	220		5.0	5.4	80	
LB 3218T331□		RoHS	330		4.0	7.0	65	
LB 3218T471□		RoHS	470		3.5	14	54	
LB 3218T681□		RoHS	680		3.0	17	45	
LB 3218T102□		RoHS	1000	2.4	27	39	0.252	

● **LBMF1608 TYPE**

Ordering code		EHS (Environmental Hazardous Substances)	Inductance [μH]	Inductance Tolerance	Self-resonant frequency [MHz] min.	DC Resistance [Ω] (±30%)	Rated current [mA] max.	Measuring frequency [MHz]
LBMF1608T1R0M		RoHS	1.0	±20%	100	0.09	230	7.96
LBMF1608T2R2M		RoHS	2.2		80	0.17	160	
LBMF1608T3R3M		RoHS	3.3		60	0.22	130	
LBMF1608T4R7M		RoHS	4.7		45	0.24	110	
LBMF1608T100□		RoHS	10	±10% ±20%	32	0.36	80	2.52
LBMF1608T220□		RoHS	22		16	1.0	50	
LBMF1608T470□		RoHS	47		11	2.5	35	

● **LBC3225 TYPE**

Ordering code		EHS (Environmental Hazardous Substances)	Inductance [μH]	Inductance Tolerance	Self-resonant frequency [MHz] min.	DC Resistance [Ω] (±30%)	Rated current [mA] max.	Measuring frequency [MHz]
LB C3225T1R0MR		RoHS	1.0	±20%	250	0.055	1100	0.1
LB C3225T1R5MR		RoHS	1.5		220	0.060	1000	
LB C3225T2R2MR		RoHS	2.2		190	0.080	930	
LB C3225T3R3MR		RoHS	3.3		160	0.095	820	
LB C3225T4R7MR		RoHS	4.7		70	0.100	680	
LB C3225T6R8MR		RoHS	6.8		50	0.120	620	
LB C3225T100□R		RoHS	10	±10% ±20%	23	0.133	540	
LB C3225T150□R		RoHS	15		20	0.195	420	
LB C3225T220□R		RoHS	22		17	0.270	330	
LB C3225T330□R		RoHS	33		13	0.410	300	
LB C3225T470□R		RoHS	47		10	0.670	220	
LB C3225T680□R		RoHS	68		8	1.00	190	
LB C3225T101□R		RoHS	100	6	1.40	150		

● **LBC2518 TYPE**

Ordering code		EHS (Environmental Hazardous Substances)	Inductance [μH]	Inductance Tolerance	Self-resonant frequency [MHz] min.	DC Resistance [Ω] (±30%)	Rated current [mA] max.	Measuring frequency [MHz]
LB C2518T1R0M		RoHS	1.0	±20%	100	0.08	775	7.96
LB C2518T1R0MR		RoHS	1.0		100	0.065	890	
LB C2518T1R5M		RoHS	1.5		80	0.11	730	
LB C2518T2R2M		RoHS	2.2		68	0.13	630	
LB C2518T3R3M		RoHS	3.3		54	0.16	560	
LB C2518T4R7M		RoHS	4.7		41	0.20	510	
LB C2518T6R8M		RoHS	6.8	38	0.30	420	2.52	
LB C2518T100□		RoHS	10	30	0.36	375		
LB C2518T150□		RoHS	15	23	0.65	285		
LB C2518T220□		RoHS	22	19	0.77	250		
LB C2518T330□		RoHS	33	15	1.5	185		
LB C2518T470□		RoHS	47	12	1.9	165		
LB C2518T680□		RoHS	68	±10% ±20%	9.5	2.8	140	0.796
LB C2518T101□		RoHS	100		9.0	3.7	125	
LB C2518T151□		RoHS	150		7.0	6.1	95	
LB C2518T221□		RoHS	220		5.5	8.4	80	
LB C2518T331□		RoHS	330		4.5	12.3	65	
LB C2518T471□		RoHS	470		4.5	22	50	
LB C2518T681□		RoHS	680	3.0	28	45		

□ Please specify the Inductance tolerance code (K or M)

\* This catalog contains the typical specification only due to the limitation of space. When you consider purchase of our products, please check our specification. For details of each product (characteristics graph, reliability information, precautions for use, and so on), see our Web site (<http://www.ty-top.com/>) or CD catalogs.

**PART NUMBERS**

● **LBC2016 TYPE**

Ordering code		EHS (Environmental Hazardous Substances)	Inductance 〔μH〕	Inductance Tolerance	Self-resonant frequency 〔MHz〕min.	DC Resistance 〔Ω〕(±30%)	Rated current 〔mA〕 max.	Measuring frequency 〔MHz〕
LB C2016T1R0M		RoHS	1.0	±20%	100	0.10	690	7.96
LB C2016T1R5M		RoHS	1.5		80	0.15	600	
LB C2016T2R2M		RoHS	2.2		70	0.20	520	
LB C2016T3R3M		RoHS	3.3		55	0.27	410	
LB C2016T4R7M		RoHS	4.7		45	0.37	355	
LB C2016T6R8M		RoHS	6.8	±10% ±20%	38	0.59	290	2.52
LB C2016T100□		RoHS	10		32	0.82	245	
LB C2016T150□		RoHS	15		28	1.2	200	
LB C2016T220□		RoHS	22		16	1.8	165	
LB C2016T330□		RoHS	33		14	2.8	135	
LB C2016T470□		RoHS	47		11	4.3	110	
LB C2016T680□		RoHS	68		10	7.0	95	
LB C2016T101□		RoHS	100	8	8.0	75	0.796	

● **LBC2012 TYPE**

Ordering code		EHS (Environmental Hazardous Substances)	Inductance 〔μH〕	Inductance Tolerance	Self-resonant frequency 〔MHz〕min.	DC Resistance 〔Ω〕(±30%)	Rated current 〔mA〕 max.	Measuring frequency 〔MHz〕
LB C2012T1R0M		RoHS	1.0	±20%	100	0.19	620	7.96
LB C2012T2R2M		RoHS	2.2		70	0.33	430	
LB C2012T4R7M		RoHS	4.7		45	0.50	295	
LB C2012T100□		RoHS	10	±10% ±20%	40	1.2	200	2.52
LB C2012T220□		RoHS	22		16	3.7	130	
LB C2012T470□		RoHS	47		11	5.8	90	

● **LBR2518 TYPE**

Ordering code		EHS (Environmental Hazardous Substances)	Inductance 〔μH〕	Inductance Tolerance	Self-resonant frequency 〔MHz〕min.	DC Resistance 〔Ω〕(±30%)	Rated current 〔mA〕 max.	Measuring frequency 〔MHz〕
LB R2518T1R0M		RoHS	1.0	±20%	100	0.045	960	7.96
LB R2518T2R2M		RoHS	2.2		68	0.07	480	
LB R2518T4R7M		RoHS	4.7		45	0.10	345	
LB R2518T100□		RoHS	10	±10% ±20%	30	0.19	235	2.52
LB R2518T220□		RoHS	22		19	0.44	175	
LB R2518T470□		RoHS	47		11	0.84	120	
LB R2518T101□		RoHS	100		9	1.89	80	0.796

● **LBR2012 TYPE**

Ordering code		EHS (Environmental Hazardous Substances)	Inductance 〔μH〕	Inductance Tolerance	Self-resonant frequency 〔MHz〕min.	DC Resistance 〔Ω〕(±30%)	Rated current 〔mA〕 max.	Measuring frequency 〔MHz〕
LB R2012T1R0M		RoHS	1.0	±20%	100	0.07	400	7.96
LB R2012T2R2M		RoHS	2.2		80	0.13	260	
LB R2012T4R7M		RoHS	4.7		45	0.24	200	
LB R2012T100□		RoHS	10	±10% ±20%	32	0.36	150	2.52
LB R2012T220□		RoHS	22		16	1.0	100	
LB R2012T470□		RoHS	47		11	1.7	75	
LB R2012T101□		RoHS	100		8	4.0	50	0.796

□ Please specify the Inductance tolerance code (K or M)

\* This catalog contains the typical specification only due to the limitation of space. When you consider purchase of our products, please check our specification.  
For details of each product (characteristics graph, reliability information, precautions for use, and so on), see our Web site (<http://www.ty-top.com/>) or CD catalogs.

DC Bias characteristics (Measured by HP4285A+42841A)

Standard Type

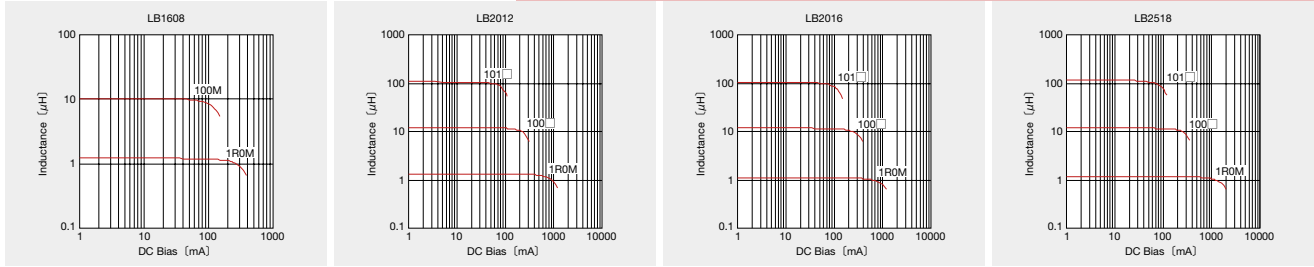

Standard Type

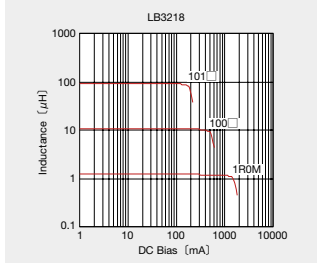

High Current Type

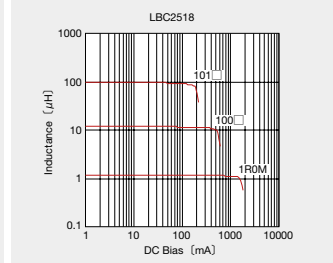
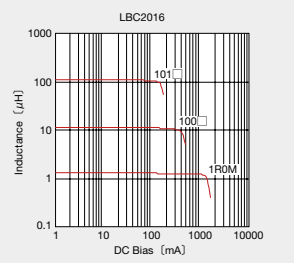
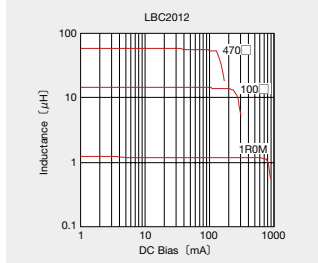

High Current Type

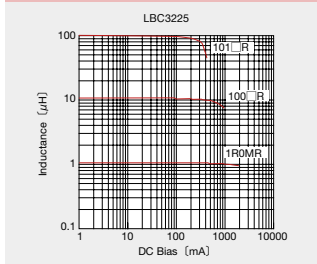

Low Rdc Type

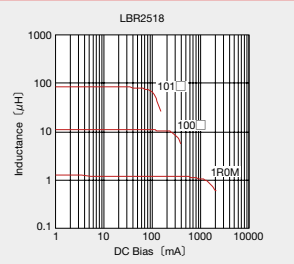
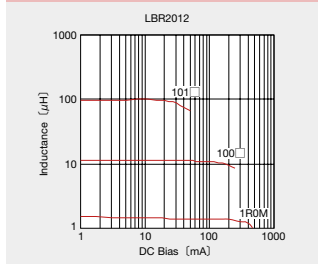

Bottom-surface electrode Type

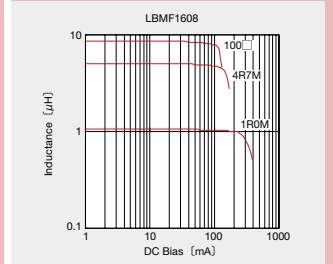

Impedance-vs-Frequency characteristics (Measured by HP4291A)

Standard Type

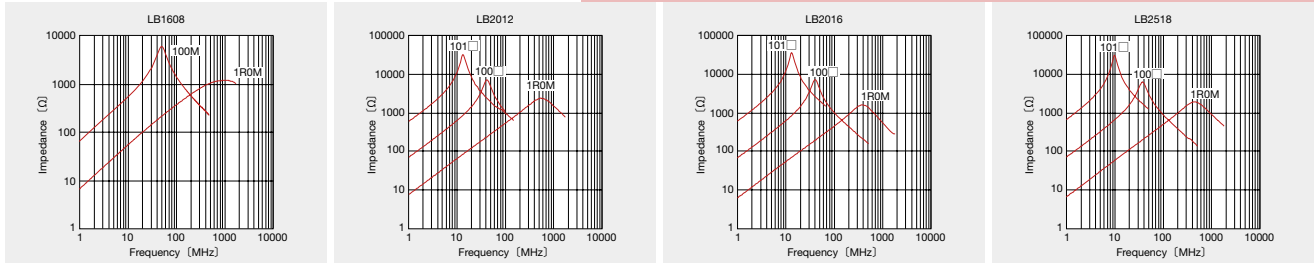

Standard Type

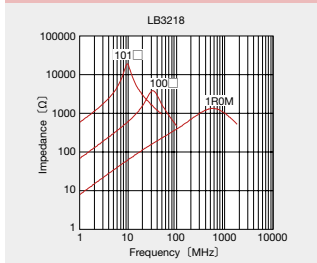

High Current Type

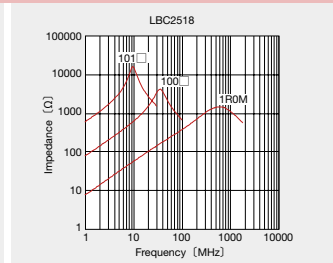
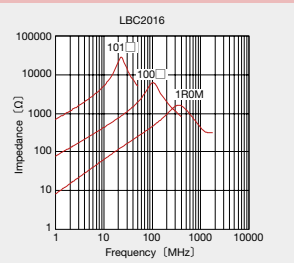
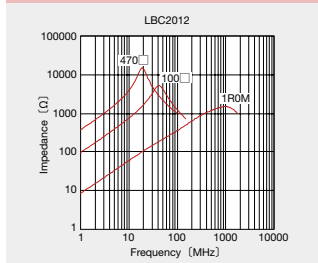

High Current Type

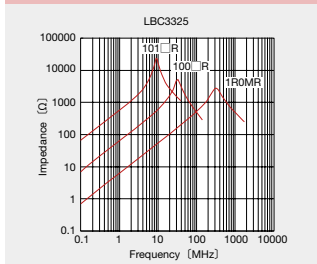

Low Rdc Type

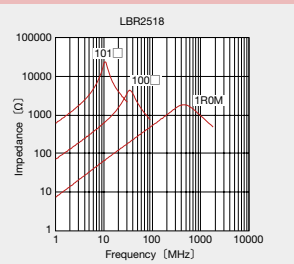
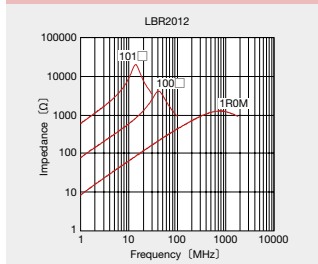

Bottom-surface electrode Type

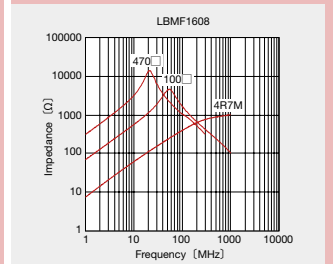

\* This catalog contains the typical specification only due to the limitation of space. When you consider purchase of our products, please check our specification. For details of each product (characteristics graph, reliability information, precautions for use, and so on), see our Web site (<http://www.ty-top.com/>) or CD catalogs.

# WOUND CHIP POWER INDUCTORS (CB SERIES)



REFLOW

## FEATURES

- This series corresponds to high electric current compared with LB/LBC series.  
Wound Chip Inductors that can be used for small DC/DC converters and are suitable for choke uses.
- CBMF 1608 Series**  
The best efficiency design is achieved by adopting bottom-surface electrode structure.  
Wound Chip Inductors that are suitable for module design which needs high electric current like DC/DC converters.

## APPLICATIONS

- DSC/DVC/HDD, LCD, portable telephones, game equipment.  
Various audio-visual equipment, various communication equipment, etc.

## ORDERING CODE

Ordering Code: C B  $\triangle$  2 0 1 2 T 1 0 0  $\triangle$   $\triangle$   $\triangle$   $\triangle$   $\triangle$

<b>1 Type</b>	CB Wound chip power inductor										
<b>2 Characteristic Spec</b>	<table border="1"> <tr><td><math>\triangle</math></td><td>Low Rdc</td></tr> <tr><td>C</td><td>High current</td></tr> <tr><td>L</td><td>Low profile</td></tr> <tr><td>MF</td><td>Bottom-surface electrode</td></tr> </table>	$\triangle$	Low Rdc	C	High current	L	Low profile	MF	Bottom-surface electrode		
$\triangle$	Low Rdc										
C	High current										
L	Low profile										
MF	Bottom-surface electrode										
<b>3 External Dimensions (mm)</b>	<table border="1"> <tr><td>1608 (0603)</td><td>1.6×0.8</td></tr> <tr><td>2012 (0805)</td><td>2.0×1.25</td></tr> <tr><td>2016 (0806)</td><td>2.0×1.6</td></tr> <tr><td>2518 (1007)</td><td>2.5×1.8</td></tr> <tr><td>3225 (1210)</td><td>3.2×2.5</td></tr> </table>	1608 (0603)	1.6×0.8	2012 (0805)	2.0×1.25	2016 (0806)	2.0×1.6	2518 (1007)	2.5×1.8	3225 (1210)	3.2×2.5
1608 (0603)	1.6×0.8										
2012 (0805)	2.0×1.25										
2016 (0806)	2.0×1.6										
2518 (1007)	2.5×1.8										
3225 (1210)	3.2×2.5										
<b>4 Packaging</b>	T Tape & Reel										
<b>5 Nominal Inductance (μH)</b>	<table border="1"> <tr><td>example</td><td></td></tr> <tr><td>1R0</td><td>1</td></tr> <tr><td>100</td><td>10</td></tr> <tr><td>101</td><td>100</td></tr> </table> <p>※R=decimal point</p>	example		1R0	1	100	10	101	100		
example											
1R0	1										
100	10										
101	100										
<b>6 Inductance Tolerances (%)</b>	<table border="1"> <tr><td>K</td><td>±10</td></tr> <tr><td>M</td><td>±20</td></tr> </table>	K	±10	M	±20						
K	±10										
M	±20										
<b>7 Special code</b>	<table border="1"> <tr><td><math>\triangle</math></td><td>Standard products</td></tr> <tr><td>R</td><td>Low Rdc type</td></tr> </table>	$\triangle$	Standard products	R	Low Rdc type						
$\triangle$	Standard products										
R	Low Rdc type										
<b>8 Internal code</b>	<table border="1"> <tr><td><math>\triangle\triangle\triangle</math></td><td>Standard Products</td></tr> <tr><td><math>\triangle</math></td><td>Blank space</td></tr> </table>	$\triangle\triangle\triangle$	Standard Products	$\triangle$	Blank space						
$\triangle\triangle\triangle$	Standard Products										
$\triangle$	Blank space										

## EXTERNAL DIMENSIONS/STANDARD QUANTITY

Type	L	W	T	e	Standard Quantity [pcs]	
					Paper Tape	Embossed Tape
CBC3225	3.2±0.2 (0.126±0.008)	2.5±0.2 (0.098±0.008)	2.5±0.2 (0.098±0.008)	0.6±0.3 (0.024±0.012)	—	1000
CB2518 CBC2518	2.5±0.2 (0.098±0.008)	1.8±0.2 (0.071±0.008)	1.8±0.2 (0.071±0.008)	0.5±0.2 (0.020±0.008)	—	2000
CB2016 CBC2016	2.0±0.2 (0.079±0.008)	1.6±0.2 (0.063±0.008)	1.6±0.2 (0.063±0.008)	0.5±0.2 (0.020±0.008)	—	2000
CB2012 CBC2012	2.0±0.2 (0.079±0.008)	1.25±0.2 (0.049±0.008)	1.25±0.2 (0.049±0.008)	0.5±0.2 (0.020±0.008)	—	2000
CBL2012	2.0±0.2 (0.079±0.008)	1.25±0.2 (0.049±0.008)	0.9±0.1 (0.035±0.004)	0.5±0.2 (0.020±0.008)	4000	—
CBMF1608	1.6±0.2 (0.063±0.2)	0.8±0.2 (0.031±0.008)	0.8±0.2 (0.031±0.008)	0.45±0.15 (0.016±0.006)	—	3000

Unit : mm

Recommended Land Patterns

Surface Mounting  
 • Mounting and soldering conditions should be checked beforehand.  
 • Applicable soldering process to those products is reflow soldering only.  
 • Recommended Land Patterns

Unit : mm (inch)

## AVAILABLE CAPACITANCE RANGE

Inductance [μH]	Type		CB2518	CB2016	CB2012	CBC3225	CBC2518	CBC2016	CBC2012	CBC2012	CBMF1608							
	Range																	
1	1200	Rdc±30% [Ω]	600	1μH 0.09	500	1μH 0.15	1440	1μH 0.055	1000	1μH 0.08	1100	1μH 0.1	700	1μH 0.19	620	1μH 0.15	350	1μH 0.09
22	510	0.09	510	0.13	410	0.23	1130	0.08	890	0.13	750	0.2	530	0.33	530	0.33	230	0.17
10	250	2.40	250	0.5	200	0.5	900	0.133	480	0.36	380	0.82	240	1.2	440	1.0	115	0.36
47	110	0.95	110	2.4	90	3.7	390	0.67	240	1.90	150	4.3	120	5.8	100	4.2	50	2.5
100	60	2.1	70	4.5	60	7	270	1.4	160	3.7	110	8	47μH	47μH	47μH	47μH	47μH	47μH
1000	25	24	100μH	100μH	100μH	100μH	65	28	100μH	680μH	100μH	100μH	100μH	100μH	100μH	100μH	100μH	100μH

\* This catalog contains the typical specification only due to the limitation of space. When you consider purchase of our products, please check our specification. For details of each product (characteristics graph, reliability information, precautions for use, and so on), see our Web site (<http://www.ty-top.com/>) or CD catalogs.

**PART NUMBERS**

**●CB2012 TYPE**

Ordering code	EHS (Environmental Hazardous Substances)	Inductance ( $\mu$ H)	Inductance Tolerance	Self-resonant frequency [MHz] min.	Resistance DC [ $\Omega$ ] ( $\pm 30\%$ )	Rated current [mA]		Measuring frequency [MHz]
						Saturation current Idc1	Temperature rise current Idc2	
CB 2012T1R0M	RoHS	1.0	$\pm 20\%$	100	0.15	500	900	7.96
CB 2012T2R2M	RoHS	2.2		80	0.23	410	770	
CB 2012T3R3M	RoHS	3.3		55	0.30	330	650	
CB 2012T4R7M	RoHS	4.7		45	0.40	300	580	
CB 2012T6R8M	RoHS	6.8		38	0.47	250	540	
CB 2012T100□	RoHS	10	$\pm 10\%$ $\pm 20\%$	32	0.70	190	440	2.52
CB 2012T100□R	RoHS	10		32	0.50	200	520	
CB 2012T150□	RoHS	15		28	1.3	170	320	
CB 2012T220□	RoHS	22		16	1.7	135	280	
CB 2012T470□	RoHS	47		11	3.7	90	190	
CB 2012T680□	RoHS	68		10	6.0	70	140	
CB 2012T101□	RoHS	100		8	7.0	60	130	

**●CB2016 TYPE**

Ordering code	EHS (Environmental Hazardous Substances)	Inductance ( $\mu$ H)	Inductance Tolerance	Self-resonant frequency [MHz] min.	Resistance DC [ $\Omega$ ] ( $\pm 30\%$ )	Rated current [mA]		Measuring frequency [MHz]
						Saturation current Idc1	Temperature rise current Idc2	
CB 2016T1R0M	RoHS	1.0	$\pm 20\%$	100	0.09	600	1100	7.96
CB 2016T1R5M	RoHS	1.5		80	0.11	550	1000	
CB 2016T2R2M	RoHS	2.2		70	0.13	510	1000	
CB 2016T3R3M	RoHS	3.3		55	0.20	400	800	
CB 2016T4R7M	RoHS	4.7		45	0.25	340	740	
CB 2016T6R8M	RoHS	6.8	38	0.35	300	600	2.52	
CB 2016T100□	RoHS	10	32	0.50	250	520		
CB 2016T150□	RoHS	15	28	0.70	210	440		
CB 2016T220□	RoHS	22	16	1.0	165	370		
CB 2016T330□	RoHS	33	14	1.7	130	270		
CB 2016T470□	RoHS	47	11	2.4	110	240		
CB 2016T680□	RoHS	68	10	3.0	90	210		
CB 2016T101□	RoHS	100	8	4.5	70	170		
								0.796

**●CB2518 TYPE**

Ordering code	EHS (Environmental Hazardous Substances)	Inductance ( $\mu$ H)	Inductance Tolerance	Self-resonant frequency [MHz] min.	Resistance DC [ $\Omega$ ] ( $\pm 30\%$ )	Rated current [mA]		Measuring frequency [MHz]
						Saturation current Idc1	Temperature rise current Idc2	
CB 2518T1R0M	RoHS	1.0	$\pm 20\%$	100	0.06	1200	1500	7.96
CB 2518T1R5M	RoHS	1.5		80	0.07	650	1400	
CB 2518T2R2M	RoHS	2.2		68	0.09	510	1300	
CB 2518T3R3M	RoHS	3.3		54	0.11	440	1200	
CB 2518T4R7MR	RoHS	4.7		46	0.10	310	1200	
CB 2518T4R7M	RoHS	4.7	46	0.13	340	1100	2.52	
CB 2518T6R8M	RoHS	6.8	38	0.15	270	930		
CB 2518T100□	RoHS	10	30	0.25	250	820		
CB 2518T150□	RoHS	15	23	0.32	180	650		
CB 2518T220□	RoHS	22	19	0.50	165	580		
CB 2518T330□	RoHS	33	15	0.70	130	460		
CB 2518T470□	RoHS	47	12	0.95	110	420		
CB 2518T680□	RoHS	68	9.5	1.5	70	310		
CB 2518T101□	RoHS	100	9.0	2.1	60	260	0.796	
CB 2518T151□	RoHS	150	7.0	3.2	55	210		
CB 2518T221□	RoHS	220	5.5	4.5	50	180		
CB 2518T331□	RoHS	330	4.5	7.0	40	140		
CB 2518T471□	RoHS	470	3.5	10	35	120		
CB 2518T681□	RoHS	680	3.0	17	30	90		
CB 2518T102□	RoHS	1000	2.4	24	25	75		

**●CBC2012 TYPE**

Ordering code	EHS (Environmental Hazardous Substances)	Inductance ( $\mu$ H)	Inductance Tolerance	Self-resonant frequency [MHz] min.	Resistance DC [ $\Omega$ ] ( $\pm 30\%$ )	Rated current [mA]		Measuring frequency [MHz]
						Saturation current Idc1	Temperature rise current Idc2	
CB C2012T1R0M	RoHS	1.0	$\pm 20\%$	100	0.19	700	840	7.96
CB C2012T2R2M	RoHS	2.2		70	0.33	530	640	
CB C2012T4R7M	RoHS	4.7		45	0.50	360	520	
CB C2012T100□	RoHS	10	$\pm 10\%$ $\pm 20\%$	40	1.2	240	340	2.52
CB C2012T220□	RoHS	22		16	3.7	170	190	
CB C2012T470□	RoHS	47		11	5.8	120	150	

□Please specify the Inductance tolerance code( Kor M)

- ※) The saturation current value(Idc1) is the DC current value having inductance decrease down to 30%. (at 20°C)
- ※) The temperature rise current value(Idc2) is the DC current value having temperature increase up to 40°C. (at 20°C)
- ※) The maximum rated current is the DC current value that satisfies both of DC saturation current value and temperature rise current value.

\* This catalog contains the typical specification only due to the limitation of space. When you consider purchase of our products, please check our specification. For details of each product (characteristics graph, reliability information, precautions for use, and so on), see our Web site (<http://www.ty-top.com/>) or CD catalogs.



**PART NUMBERS**

● **CBC2016 TYPE**

Ordering code	EHS (Environmental Hazardous Substances)	Inductance [μH]	Inductance Tolerance	Self-resonant frequency [MHz] min.	Resistance DC [Ω] (±30%)	Rated current [mA]		Measuring frequency [MHz]
						Saturation current I <sub>dc1</sub>	Temperature rise current I <sub>dc2</sub>	
CB C2016T1R0M	RoHS	1.0	±20%	100	0.10	1100	1100	7.96
CB C2016T1R5M	RoHS	1.5		80	0.15	1000	1000	
CB C2016T2R2M	RoHS	2.2		70	0.20	750	720	
CB C2016T3R3M	RoHS	3.3		55	0.27	600	610	
CB C2016T4R7M	RoHS	4.7		45	0.37	550	530	
CB C2016T6R8M	RoHS	6.8	±10% ±20%	38	0.59	450	450	2.52
CB C2016T100□	RoHS	10		32	0.82	380	350	
CB C2016T150□	RoHS	15		28	1.2	300	300	
CB C2016T220□	RoHS	22		16	1.8	250	240	
CB C2016T330□	RoHS	33		14	2.8	220	220	
CB C2016T470□	RoHS	47		11	4.3	150	150	
CB C2016T680□	RoHS	68		10	7.0	130	130	
CB C2016T101□	RoHS	100	8	8.0	110	110	0.796	

● **CBC2518 TYPE**

Ordering code	EHS (Environmental Hazardous Substances)	Inductance [μH]	Inductance Tolerance	Self-resonant frequency [MHz] min.	Resistance DC [Ω] (±30%)	Rated current [mA]		Measuring frequency [MHz]
						Saturation current I <sub>dc1</sub>	Temperature rise current I <sub>dc2</sub>	
CB C2518T1R0M	RoHS	1.0	±20%	100	0.08	1000	1200	7.96
CB C2518T1R5M	RoHS	1.5		80	0.11	950	1190	
CB C2518T2R2M	RoHS	2.2		68	0.13	890	1100	
CB C2518T3R3M	RoHS	3.3		54	0.16	730	1020	
CB C2518T4R7M	RoHS	4.7		41	0.20	680	920	
CB C2518T6R8M	RoHS	6.8	±10% ±20%	38	0.30	550	740	2.52
CB C2518T100□	RoHS	10		30	0.36	480	680	
CB C2518T150□	RoHS	15		23	0.65	350	500	
CB C2518T220□	RoHS	22		19	0.77	320	460	
CB C2518T330□	RoHS	33		15	1.5	270	320	
CB C2518T470□	RoHS	47		12	1.9	240	290	
CB C2518T680□	RoHS	68		9.5	2.8	200	200	
CB C2518T101□	RoHS	100	9.0	3.7	160	170	0.796	
CB C2518T151□	RoHS	150	7.0	6.1	140	130		
CB C2518T221□	RoHS	220	5.5	8.4	115	110		
CB C2518T331□	RoHS	330	4.5	12.3	100	90		
CB C2518T471□	RoHS	470	3.5	22	80	70		
CB C2518T681□	RoHS	680	3.0	28	65	60		

● **CBC3225 TYPE**

Ordering code	EHS (Environmental Hazardous Substances)	Inductance [μH]	Inductance Tolerance	Self-resonant frequency [MHz] min.	Resistance DC [Ω] (±30%)	Rated current [mA]		Measuring frequency [MHz]
						Saturation current I <sub>dc1</sub>	Temperature rise current I <sub>dc2</sub>	
CB C3225T1R0MR	RoHS	1.0	±20%	250	0.055	2000	1440	0.1
CB C3225T1R5MR	RoHS	1.5		220	0.06	2000	1310	
CB C3225T2R2MR	RoHS	2.2		190	0.08	2000	1130	
CB C3225T3R3MR	RoHS	3.3		160	0.095	2000	1040	
CB C3225T4R7MR	RoHS	4.7		70	0.10	1250	1010	
CB C3225T6R8MR	RoHS	6.8	±10% ±20%	50	0.12	950	940	0.1
CB C3225T100□R	RoHS	10		23	0.133	900	900	
CB C3225T150□R	RoHS	15		20	0.195	730	850	
CB C3225T220□R	RoHS	22		17	0.27	620	780	
CB C3225T330□R	RoHS	33		13	0.41	500	570	
CB C3225T470□R	RoHS	47		10	0.67	390	480	
CB C3225T680□R	RoHS	68		8	1.0	320	410	
CB C3225T101□R	RoHS	100	6	1.4	270	340		

● **CBL2012 TYPE**

Ordering code	EHS (Environmental Hazardous Substances)	Inductance [μH]	Inductance Tolerance	Self-resonant frequency [MHz] min.	Resistance DC [Ω] (±30%)	Rated current [mA]		Measuring frequency [MHz]
						Saturation current I <sub>dc1</sub>	Temperature rise current I <sub>dc2</sub>	
CB L2012T1R0M	RoHS	1.0	±20%	100	0.15	620	950	0.1
CB L2012T2R2M	RoHS	2.2		80	0.39	440	590	
CB L2012T4R7M	RoHS	4.7		45	0.66	275	490	
CB L2012T100M	RoHS	10		32	1.0	205	370	
CB L2012T220M	RoHS	22		23	2.1	150	250	
CB L2012T470M	RoHS	47	11	4.2	100	140		

□ Please specify the Inductance tolerance code (K or M)

※) The saturation current value (I<sub>dc1</sub>) is the DC current value having inductance decrease down to 30%. (at 20°C)

※) The temperature rise current value (I<sub>dc2</sub>) is the DC current value having temperature increase up to 40°C. (at 20°C)

※) The maximum rated current is the DC current value that satisfies both of DC saturation current value and temperature rise current value.

\* This catalog contains the typical specification only due to the limitation of space. When you consider purchase of our products, please check our specification. For details of each product (characteristics graph, reliability information, precautions for use, and so on), see our Web site (<http://www.ty-top.com/>) or CD catalogs.

■ PART NUMBERS

● CBMF1608 TYPE

Ordering code	EHS (Environmental Hazardous Substances)	Inductance ( $\mu$ H)	Inductance Tolerance	Self-resonant frequency (MHz) min.	Resistance DC [ $\Omega$ ] ( $\pm$ 30%)	Rated current (mA)		Measuring frequency [MHz]
						Saturation current Idc1	Temperature rise current Idc2	
CBMF1608T1R0M	RoHS	1.0	$\pm$ 20%	100	0.09	290	770	7.96
CBMF1608T2R2M	RoHS	2.2		80	0.17	190	560	
CBMF1608T3R3M	RoHS	3.3		60	0.22	170	500	
CBMF1608T4R7M	RoHS	4.7		45	0.24	145	470	
CBMF1608T100□	RoHS	10.0	$\pm$ 10% $\pm$ 20%	32	0.36	115	380	2.52
CBMF1608T220□	RoHS	22		16	1.0	70	230	
CBMF1608T470□	RoHS	47		11	2.5	50	140	

□ Please specify the Inductance tolerance code (K or M)

※) The saturation current value (Idc1) is the DC current value having inductance decrease down to 30%. (at 20°C)

※) The temperature rise current value (Idc2) is the DC current value having temperature increase up to 40°C. (at 20°C)

※) The maximum rated current is the DC current value that satisfies both of DC saturation current value and temperature rise current value.

\* This catalog contains the typical specification only due to the limitation of space. When you consider purchase of our products, please check our specification.  
For details of each product (characteristics graph, reliability information, precautions for use, and so on), see our Web site (<http://www.ty-top.com/>) or CD catalogs.

# ELECTRICAL CHARACTERISTICS

## DC Bias characteristics Measured by HP4285A+42841A

### Low Rdc Type

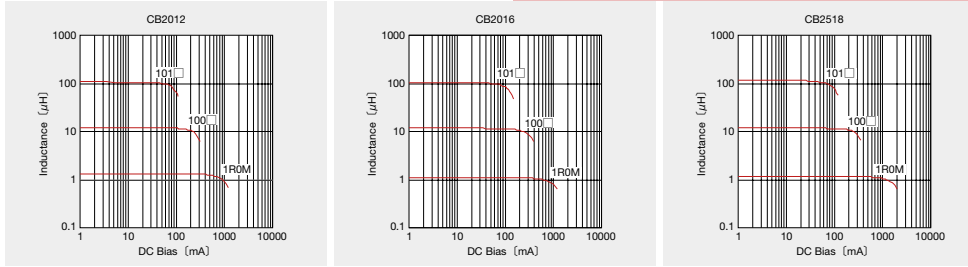

### High Current Type

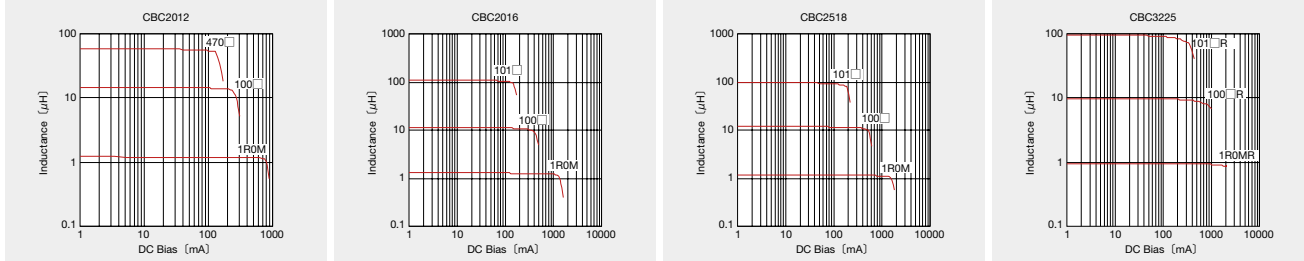

### Low Profile Type

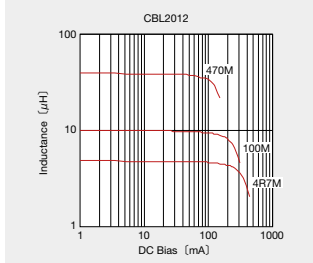

### Bottom-surface electrode Type

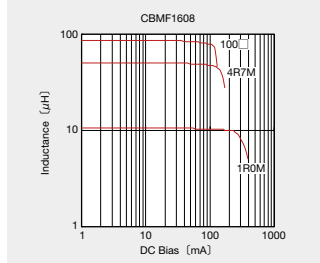

## Impedance-vs-Frequency characteristics Measured by HP4291A

### Low Rdc Type

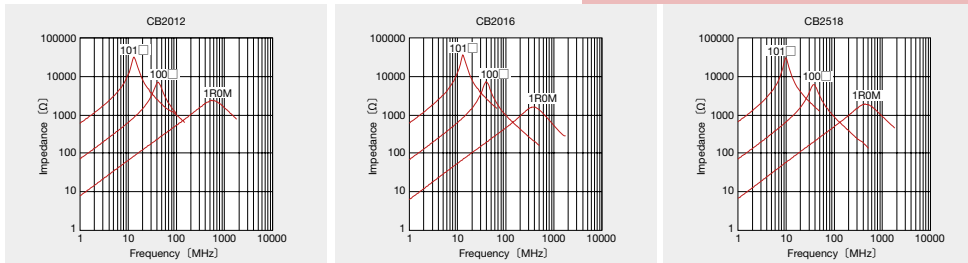

### High Current Type

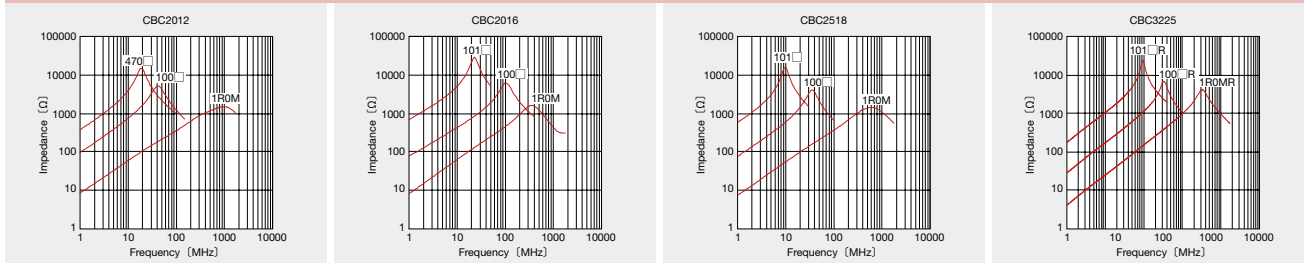

### Low Profile Type

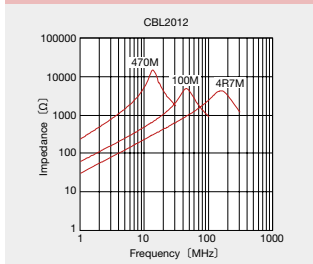

### Bottom-surface electrode Type

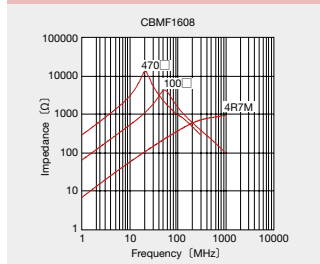

\* This catalog contains the typical specification only due to the limitation of space. When you consider purchase of our products, please check our specification. For details of each product (characteristics graph, reliability information, precautions for use, and so on), see our Web site (<http://www.ty-top.com/>) or CD catalogs.

# WOUND CHIP INDUCTORS FOR SIGNAL LINE (LB/LE SERIES M TYPE)



LB: REFLOW LE: WAVE REFLOW

## FEATURES

- **LBM2016 Series**  
High Q and narrow tolerance are achieved by adopting bottom-surface electrode structure. Wound Chip Inductors that are suitable for module design of signal line uses.
- **LEM2520 Series**  
A high-quality inductor that is simple to mass-produce and conforms to the same production process and basic construction as an axial lead type inductor.

## APPLICATIONS

- DSC/DVC/HDD, LCD, portable telephones, game equipment. Various audio-visual equipment, various communication equipment, etc.

## ORDERING CODE

L B M | 2 0 1 6 | T 1 0 0 | J △

① Type		② External Dimensions (mm)		③ Packaging		④ Nominal Inductance (μH)		⑤ Inductance Tolerances		⑥ Internal code	
LBM	Wound chip inductor for signal line	2016	2.0×1.6	T	Tape & Reel	example		J	±5%	△	Standard Products
LEM	Wound chip inductor for signal line	2520	2.5×2.0			R12	0.12	K	±10%		△=Blank space
						1R0	1.00				
						100	10.0				

※R=decimal point

## EXTERNAL DIMENSIONS/STANDARD QUANTITY

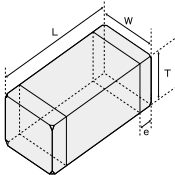
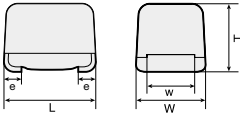
		LBM2016			LEM2520				
									
Type	L	W	T	e	W	Standard Quantity [pcs]			
						Paper Tape	Embossed Tape		
LBM2016	2.0±0.2 (0.08±0.008)	1.6±0.2 (0.063±0.008)	1.6±0.2 (0.063±0.008)	0.5±0.2 (0.02±0.008)		-	2000		
LEM2520	2.5±0.2 (0.098±0.008)	2.0±0.2 (0.079±0.008)	1.8±0.2 (0.071±0.008)	0.45 (0.018)	1.4±0.1 (0.055±0.004)				

Unit : mm (inch)

### Recommended Land Patterns

#### Surface Mounting

- Mounting and soldering conditions should be checked beforehand.
- Applicable soldering process to those products is reflow soldering only. (LB only)
- Recommended Land Patterns

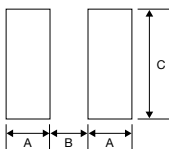

Unit : mm

TYPE	A	B	C
LBM2016	0.7	0.8	1.8
LEM2520	0.9	1.5	1.5

## AVAILABLE CAPACITANCE RANGE

Range	Type		LBM2016		LEM2520	
	Inductance [μH]	Ordinary type	Idc [mA]	Rdc ±30% [Ω]	Idc [mA]	Rdc ±30% [Ω]
0.12	610	0.13	520	0.37	245	1.10
1.0	215	1.20	155	3.50	60	21.00
100						

100 μH

\* This catalog contains the typical specification only due to the limitation of space. When you consider purchase of our products, please check our specification. For details of each product (characteristics graph, reliability information, precautions for use, and so on), see our Web site (<http://www.ty-top.com/>) or CD catalogs.

**PART NUMBERS**

**LBM2016 TYPE**

Ordering code	EHS (Environmental Hazardous Substances)	Inductance (μH)	Inductance Tolerance	Q (min.)	Self-resonant frequency (MHz) min.	Resistance DC (Ω) (±30%)	Rated current (mA) (max.)	Measuring frequency (MHz)	
LB M2016TR12J	RoHS	0.12	±5%	30	600	0.13	610	25.2	
LB M2016TR15J	RoHS	0.15			550	0.15	570		
LB M2016TR18J	RoHS	0.18			500	0.15	560		
LB M2016TR22J	RoHS	0.22			450	0.20	520		
LB M2016TR27J	RoHS	0.27			425	0.21	510		
LB M2016TR33J	RoHS	0.33			400	0.21	490		
LB M2016TR39J	RoHS	0.39			375	0.26	440		
LB M2016TR47J	RoHS	0.47			350	0.26	430		
LB M2016TR56J	RoHS	0.56			300	0.29	410		
LB M2016TR68J	RoHS	0.68			270	0.32	400		
LB M2016TR82J	RoHS	0.82			250	0.34	390		
LB M2016T1R0J	RoHS	1.0			220	0.38	385		7.96
LB M2016T1R2J	RoHS	1.2			180	0.41	370		
LB M2016T1R5J	RoHS	1.5			135	0.47	350		
LB M2016T1R8J	RoHS	1.8			100	0.48	345		
LB M2016T2R2J	RoHS	2.2			75	0.54	340		
LB M2016T2R7J	RoHS	2.7			55	0.59	310		
LB M2016T3R3J	RoHS	3.3			48	0.68	290		
LB M2016T3R9J	RoHS	3.9			43	0.74	275		
LB M2016T4R7J	RoHS	4.7			40	0.78	270		
LB M2016T5R6J	RoHS	5.6		36	0.88	255	2.52		
LB M2016T6R8J	RoHS	6.8		33	0.97	240			
LB M2016T8R2J	RoHS	8.2		30	1.10	225			
LB M2016T100J	RoHS	10		27	1.20	215			
LB M2016T120J	RoHS	12		23	1.4	200			
LB M2016T150J	RoHS	15		20	1.5	190			
LB M2016T180J	RoHS	18		18	2.5	150			
LB M2016T220J	RoHS	22		17	2.8	140			
LB M2016T270J	RoHS	27		16	3.2	130			
LB M2016T330J	RoHS	33		15	3.6	125			
LB M2016T390J	RoHS	39		14	3.9	120		0.796	
LB M2016T470J	RoHS	47		13	4.1	115			
LB M2016T560J	RoHS	56		12	5.9	95			
LB M2016T680J	RoHS	68		11	7.0	90			
LB M2016T820J	RoHS	82		10	7.7	85			
LB M2016T101J	RoHS	100		9.0	8.0	80			

**LEM2520 TYPE**

Ordering code	EHS (Environmental Hazardous Substances)	Inductance (μH)	Inductance Tolerance	Q (min.)	Self-resonant frequency (MHz) min.	Resistance DC (Ω) (±30%)	Rated current (mA) (max.)	Measuring frequency (MHz)	
LEM 2520 TR12K	RoHS	0.12	±10%	30	600	0.37	520	25.2	
LEM 2520 TR15K	RoHS	0.15			550	0.42	480		
LEM 2520 TR18K	RoHS	0.18			500	0.46	460		
LEM 2520 TR22K	RoHS	0.22			450	0.52	430		
LEM 2520 TR27K	RoHS	0.27			425	0.56	420		
LEM 2520 TR33K	RoHS	0.33			400	0.60	400		
LEM 2520 TR39K	RoHS	0.39			375	0.65	375		
LEM 2520 TR47K	RoHS	0.47			350	0.68	350		
LEM 2520 TR56K	RoHS	0.56			300	0.75	325		
LEM 2520 TR68K	RoHS	0.68			270	0.85	300		
LEM 2520 TR82K	RoHS	0.82			250	1.00	260		7.96
LEM 2520 T1R0J	RoHS	1.0			220	1.10	245		
LEM 2520 T1R2J	RoHS	1.2			180	1.20	230		
LEM 2520 T1R5J	RoHS	1.5			135	1.30	220		
LEM 2520 T1R8J	RoHS	1.8			100	1.45	210		
LEM 2520 T2R2J	RoHS	2.2			75	1.55	200		
LEM 2520 T2R7J	RoHS	2.7			55	1.70	195		
LEM 2520 T3R3J	RoHS	3.3			48	1.90	185		
LEM 2520 T3R9J	RoHS	3.9			43	2.10	180		
LEM 2520 T4R7J	RoHS	4.7			40	2.30	175		
LEM 2520 T5R6J	RoHS	5.6	36	2.50	170				
LEM 2520 T6R8J	RoHS	6.8	33	2.70	165				
LEM 2520 T8R2J	RoHS	8.2	30	3.05	160				
LEM 2520 T100J	RoHS	10	27	3.50	155				
LEM 2520 T120J	RoHS	12	23	3.80	150				
LEM 2520 T150J	RoHS	15	20	4.40	140				
LEM 2520 T180J	RoHS	18	18	4.80	130				
LEM 2520 T220J	RoHS	22	17	5.50	125				
LEM 2520 T270J	RoHS	27	16	6.30	115				
LEM 2520 T330J	RoHS	33	15	7.10	110	0.796			
LEM 2520 T390J	RoHS	39	14	9.50	90				
LEM 2520 T470J	RoHS	47	13	11.10	80				
LEM 2520 T560J	RoHS	56	12	12.10	75				
LEM 2520 T680J	RoHS	68	11	16.60	70				
LEM 2520 T820J	RoHS	82	10	19.00	65				
LEM 2520 T101J	RoHS	100	9	21.00	60				

\* This catalog contains the typical specification only due to the limitation of space. When you consider purchase of our products, please check our specification. For details of each product (characteristics graph, reliability information, precautions for use, and so on), see our Web site (<http://www.ty-top.com/>) or CD catalogs.

● LBM2016

■ Q-vs-Frequency characteristics

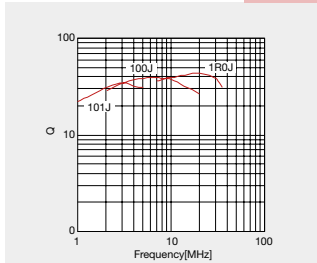

■ Impedance-vs-Frequency characteristics

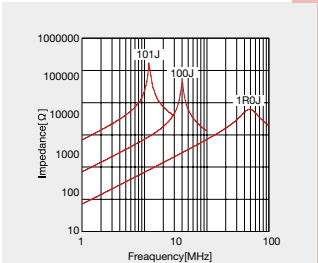

■ Inductance-vs-Frequency characteristics

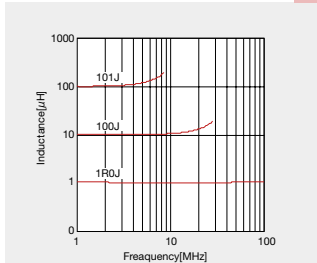

● LEM2520

■ Q-vs-Frequency characteristics

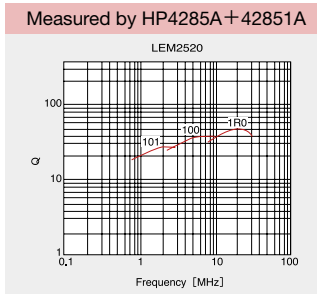

■ DC Bias characteristics

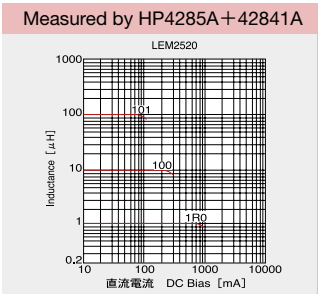

■ Temperature characteristics

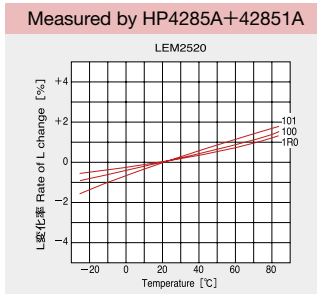

\* This catalog contains the typical specification only due to the limitation of space. When you consider purchase of our products, please check our specification. For details of each product (characteristics graph, reliability information, precautions for use, and so on), see our Web site (<http://www.ty-top.com/>) or CD catalogs.

① Minimum Quantity

Type	Standard Quantity [pcs]	
	Papar Tape	Embossed Tape
LBC3225/CBC3225	—	1000
LB3218	—	2000
LBR2518/LBC2518/LB251/CB2518/CBC2518/LEM2520	—	2000
LBM2016/LBC2016/LB2016/CB2016/CBC2016	—	2000
LB2012/LBC2012/LBR202/CB2012/CBC2012	—	3000
CBL2012	4000	—
LB1608	4000	—
LBMF1608/CBMF1608	—	3000

② Tape material

- Embossed tape

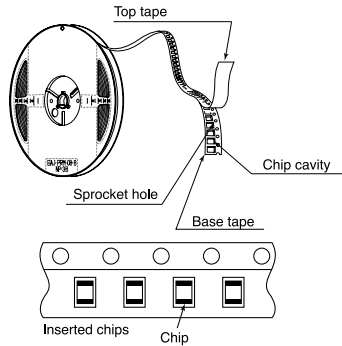

③ Taping Dimensions

- Embossed Tape (0.315 inches wide)
- Card board carrier tape (0.315 inches wide)

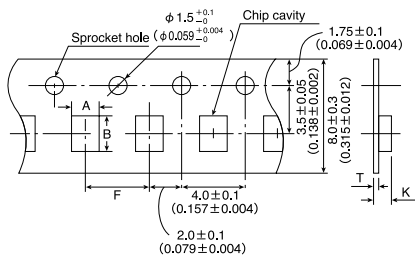

Type	Chip cavity		Insertion pitch	Tape thickness	
	A	B		T	K
LBM 2016	$1.75 \pm 0.1$ ( $0.069 \pm 0.004$ )	$2.1 \pm 0.1$ ( $0.083 \pm 0.004$ )	$4.0 \pm 0.1$ ( $0.157 \pm 0.004$ )	$0.3 \pm 0.05$ ( $0.012 \pm 0.002$ )	1.9max. (0.074)
LEM 2520	$2.3 \pm 0.1$ ( $0.091 \pm 0.004$ )	$2.7 \pm 0.1$ ( $0.106 \pm 0.004$ )	$4.0 \pm 0.1$ ( $0.157 \pm 0.004$ )	$0.3 \pm 0.05$ ( $0.012 \pm 0.002$ )	$2.1 \pm 0.1$ ( $0.083 \pm 0.004$ )
LBC3225/ CBC3225	$2.8 \pm 0.1$ ( $0.110 \pm 0.004$ )	$3.5 \pm 0.1$ ( $0.138 \pm 0.004$ )	$4.0 \pm 0.1$ ( $0.157 \pm 0.004$ )	$0.3 \pm 0.05$ ( $0.012 \pm 0.002$ )	4.0max. (0.157)
LB3218	$2.1 \pm 0.1$ ( $0.084 \pm 0.004$ )	$3.5 \pm 0.1$ ( $0.014 \pm 0.004$ )	$4.0 \pm 0.1$ ( $0.157 \pm 0.004$ )	$0.3 \pm 0.05$ ( $0.012 \pm 0.002$ )	2.2max. (0.086)
LB2518 / CB2518 LBC2518 / CBC2518 LBR2518	$2.15 \pm 0.1$ ( $0.085 \pm 0.004$ )	$2.7 \pm 0.1$ ( $0.107 \pm 0.004$ )	$4.0 \pm 0.1$ ( $0.157 \pm 0.004$ )	$0.3 \pm 0.05$ ( $0.012 \pm 0.002$ )	2.2max. (0.086)
LB2016/ CB2016 LBC2016 / CBC2016	$1.75 \pm 0.1$ ( $0.069 \pm 0.004$ )	$2.1 \pm 0.1$ ( $0.083 \pm 0.004$ )	$4.0 \pm 0.1$ ( $0.157 \pm 0.004$ )	$0.3 \pm 0.05$ ( $0.012 \pm 0.002$ )	1.9max. (0.074)
LB2012 / CB2012 LBC2012 / CBC2012 LBR2012	$1.45 \pm 0.1$ ( $0.058 \pm 0.004$ )	$2.25 \pm 0.1$ ( $0.09 \pm 0.004$ )	$4.0 \pm 0.1$ ( $0.157 \pm 0.004$ )	$0.25 \pm 0.05$ ( $0.010 \pm 0.002$ )	1.45max. (0.057)
CBL2012	$1.55 \pm 0.1$ ( $0.061 \pm 0.004$ )	$2.3 \pm 0.1$ ( $0.091 \pm 0.004$ )	$4.0 \pm 0.1$ ( $0.157 \pm 0.004$ )	1.1max. (0.044)	1.1max. (0.044)
LB1608	$1.0 \pm 0.1$ ( $0.059 \pm 0.004$ )	$1.8 \pm 0.1$ ( $0.072 \pm 0.004$ )	$4.0 \pm 0.1$ ( $0.157 \pm 0.004$ )	1.1max. (0.044)	1.1max. (0.044)
LBMF1608 / CBMF1608	$1.1 \pm 0.1$ ( $0.04 \pm 0.004$ )	$1.9 \pm 0.1$ ( $0.076 \pm 0.004$ )	$4.0 \pm 0.1$ ( $0.157 \pm 0.004$ )	$0.25 \pm 0.05$ ( $0.010 \pm 0.002$ )	1.2max. (0.047)

Unit : mm (inch)

④ Leader and Blank Portion

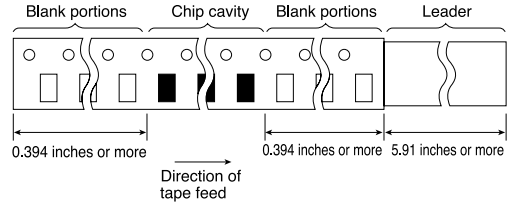

⑤ Reel Size

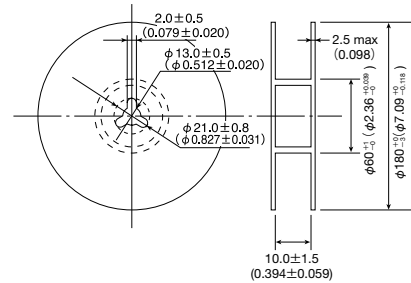

⑥ Top Tape Strength

The top tape requires a peel-off force 0.1 to 0.7N in the direction of the arrow as illustrated below.

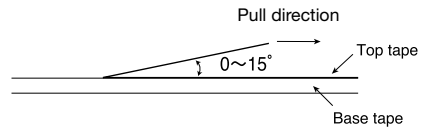

\* This catalog contains the typical specification only due to the limitation of space. When you consider purchase of our products, please check our specification. For details of each product (characteristics graph, reliability information, precautions for use, and so on), see our Web site (<http://www.ty-top.com/>) or CD catalogs.

## RELIABILITY DATA

1. Operating temperature Range						
LEM2520						-40~+85°C
LB3218	LB2518	LB2016	LB2012	LB1608	LBMF1608	-25~+105°C (Including self-generated heat)
LBC3225	LBC2518	LBC2016	LBC2012			
LBR2518	LBR2012					
CB2518	CB2016	CB2012				
CBC3225	CBC2518	CBC2016	CBC2012			
CBL2012						
CBMF1608						
LBM2016						

2. Storage						
LEM2520						-40~+85°C
LB3218	LB2518	LB2016	LB2012	LB1608	LBMF1608	
LBC3225	LBC2518	LBC2016	LBC2012			
LBR2518	LBR2012					
CB2518	CB2016	CB2012				
CBC3225	CBC2518	CBC2016	CBC2012			
CBL2012						
CBMF1608						
LBM2016						

3. Rated Current						
LEM2520						Within the specified tolerance
LB3218	LB2518	LB2016	LB2012	LB1608	LBMF1608	
LBC3225	LBC2518	LBC2016	LBC2012			
LBR2518	LBR2012					
CB2518	CB2016	CB2012				
CBC3225	CBC2518	CBC2016	CBC2012			
CBL2012						
CBMF1608						
LBM2016						

**【Test Methods and Remarks】**

LEM Series The maximum DC value having inductance decrease within 10% and temperature increase within 20°C by the application of DC bias.

4. Inductance						
LEM2520						Within the specified tolerance
LB3218	LB2518	LB2016	LB2012	LB1608	LBMF1608	
LBC3225	LBC2518	LBC2016	LBC2012			
LBR2518	LBR2012					
CB2518	CB2016	CB2012				
CBC3225	CBC2518	CBC2016	CBC2012			
CBL2012						
CBMF1608						
LBM2016						

**【Test Methods and Remarks】**

LEM Series R12~101

Measuring equipment : LCR Meter (HP4285A+42851A or its equivalent)

Measuring frequency : Specified frequency

LB · LBC · LBR · CB · CBC · CBL · LBMF · CBMF · LBM Series

Measuring equipment : LCR Meter (HP4285A or its equivalent)

5. Q						
LEM2520						Within the specified tolerance
LB3218	LB2518	LB2016	LB2012	LB1608	LBMF1608	Within the specified tolerance
LBC3225	LBC2518	LBC2016	LBC2012			
LBR2518	LBR2012					
CB2518	CB2016	CB2012				
CBC3225	CBC2518	CBC2016	CBC2012			
CBL2012						
CBMF1608						
LBM2016						

**【Test Methods and Remarks】**

LEM Series R12~101 Measuring equipment : LCR Meter (HP4285A+42851A or its equivalent)

Measuring frequency : Specified frequency

LBM Series Measuring equipment : LCR Meter (HP4285A or its equivalent)

6. DC Resistance						
LEM2520						Within the specified tolerance
LB3218	LB2518	LB2016	LB2012	LB1608	LBMF1608	
LBC3225	LBC2518	LBC2016	LBC2012			
LBR2518	LBR2012					
CB2518	CB2016	CB2012				
CBC3225	CBC2518	CBC2016	CBC2012			
CBL2012						
CBMF1608						
LBM2016						

**【Test Methods and Remarks】**

LEM · LB · LBC · LBR · CB · CBC · CBL · LBM · LBMF · CBMF Series Measuring equipment : DC Ohmmeter (HIOKI 3227 or its equivalent)

\* This catalog contains the typical specification only due to the limitation of space. When you consider purchase of our products, please check our specification. For details of each product (characteristics graph, reliability information, precautions for use, and so on), see our Web site (<http://www.ty-top.com/>) or CD catalogs.



## RELIABILITY DATA

### 7. Self-Resonant Frequency

LEM2520						Within the specified tolerance
LB3218	LB2518	LB2016	LB2012	LB1608	LBMF1608	
LBC3225	LBC2518	LBC2016	LBC2012			
LBR2518	LBR2012					
CB2518	CB2016	CB2012				
CBC3225	CBC2518	CBC2016	CBC2012			
CBL2012						
CBMF1608						
LBM2016						

#### [Test Methods and Remarks]

LEM2520 Measuring equipment : Impedance analyzer (HP4291A or its equivalent)  
 LB · LBC · LBR · CB · CBC · CBL · LBMF · CBMF Series Measuring equipment : Impedance analyzer (HP4291A or its equivalent)  
 LBM Series Measuring equipment : Network analyzer (HP8720B or its equivalent)

### 8. Temperature Characteristic

LEM2520						Inductance change: Within ±5%
LB3218	LB2518	LB2016	LB2012	LB1608	LBMF1608	Inductance change: Within ±15% LBMF1608 · LB3218 Inductance change: Within ±20%
LBC3225	LBC2518	LBC2016	LBC2012			LBC3225 · LBC2518 · LBC2016 Inductance change: Within ±20% LBC2012 Inductance change: Within ±30%
LBR2518	LBR2012					Inductance change: Within ±15%
CB2518	CB2016	CB2012				Inductance change: Within ±15%
CBC3225	CBC2518	CBC2016	CBC2012			CBC3225 · CBC2518 · CBC2016 Inductance change: Within ±20% CBC2012 Inductance change: Within ±30%
CBL2012						Inductance change: Within ±15%
CBMF1608						Inductance change: Within ±20%
LBM2016						Inductance change: Within ±5%

#### [Test Methods and Remarks]

Change of maximum inductance deviation in step 1-5

Step	1	2	3	4	5
Temperature (°C)	20	-25	20 (Reference temperature)	+85 (Maximum operating temperature)	20

### 9. Resistance to Flexure of Substrate

LEM2520						No damage.
LB3218	LB2518	LB2016	LB2012	LB1608	LBMF1608	
LBC3225	LBC2518	LBC2016	LBC2012			
LBR2518	LBR2012					
CB2518	CB2016	CB2012				
CBC3225	CBC2518	CBC2016	CBC2012			
CBL2012						
CBMF1608						
LBM2016						

#### [Test Methods and Remarks]

Warp : 2mm (LB · LBC · LBR · CB · CBC · CBL · LBM · LBMF · CBMF Series)  
 3mm (LEM2520)

Test substrate: Printed board

According to JIS C0051

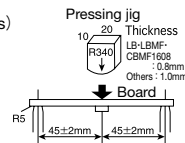

### 10. Body Strength

LEM2520						No damage.
LB3218	LB2518	LB2016	LB2012	LB1608	LBMF1608	
LBC3225	LBC2518	LBC2016	LBC2012			
LBR2518	LBR2012					
CB2518	CB2016	CB2012				
CBC3225	CBC2518	CBC2016	CBC2012			
CBL2012						
CBMF1608						
LBM2016						

#### [Test Methods and Remarks]

LB · LBC · LBR · CB · CBC · CBL · LBM · LEM2520 Applied force : 10N

Duration : 10sec.

LB1608 · LBMF1608 · CBMF1608 Applied force : 5N

Duration : 10sec.

### 11. Self Resonant Frequency

LEM2520						Inductance change : Within—10%
LB3218	LB2518	LB2016	LB2012	LB1608	LBMF1608	
LBC3225	LBC2518	LBC2016	LBC2012			
LBR2518	LBR2012					
CB2518	CB2016	CB2012				
CBC3225	CBC2518	CBC2016	CBC2012			
CBL2012						
CBMF1608						
LBM2016						

#### [Test Methods and Remarks]

Measure inductance with application of rated current using LCR metre to compare it with the initial value.

\* This catalog contains the typical specification only due to the limitation of space. When you consider purchase of our products, please check our specification.  
 For details of each product (characteristics graph, reliability information, precautions for use, and so on), see our Web site (<http://www.ty-top.com/>) or CD catalogs.

**RELIABILITY DATA**

12. Adhesion of terminal electrode					
LEM2520					
LB3218	LB2518	LB2016	LB2012	LB1608	LBMF1608
LBC3225	LBC2518	LBC2016	LBC2012		
LBR2518	LBR2012				
CB2518	CB2016	CB2012			
CBC3225	CBC2518	CBC2016	CBC2012		
CBL2012					
CBMF1608					
LBM2016					

No abnormality.

**[Test Methods and Remarks]**

LB · LBC · LBR · CB · CBC · CBL · LBM · LBMF · CBF · LEM2520 Applied force : 10N to X and Y directions  
 Duration : 5 sec.  
 Test substrate : Printed board

LB1608 · CBF1608 · LBMF1608 Applied force : 5N to X and Y directions  
 Duration : 5 sec.  
 Test substrate : Printed board

13. Resistance to vibration					
LEM2520					
LB3218	LB2518	LB2016	LB2012	LB1608	LBMF1608
LBC3225	LBC2518	LBC2016	LBC2012		
LBR2518	LBR2012				
CB2518	CB2016	CB2012			
CBC3225	CBC2518	CBC2016	CBC2012		
CBL2012					
CBMF1608					
LBM2016					

Inductance change: Within ±5% No significant abnormality in appearance.

Inductance change: Within ±10% No significant abnormality in appearance.

Inductance change: Within ±5% No significant abnormality in appearance.

**[Test Methods and Remarks]**

LEM · LB · LBC · LBR · CB · CBC · CBL · LBM · LBMF · CBF : According to JIS C5102 clause 8.2.  
 Vibration type : A  
 Directions : 2 hrs each in X, Y and Z directions. Total : 6 hrs  
 Frequency range : 10 to 55 to 10 Hz (1min.)  
 Amplitude : 1.5mm  
 Mounting method : Soldering onto printed board  
 Recovery : At least 2 hrs of recovery under the standard condition after the test, followed by the measurement within 48 hrs.  
 LEM : Recovery  
 At least 1 hr of recovery under the standard condition after the test, followed by the measurement within 2 hrs.

14. Drop test					
LEM2520					
LB3218	LB2518	LB2016	LB2012	LB1608	LBMF1608
LBC3225	LBC2518	LBC2016	LBC2012		
LBR2518	LBR2012				
CB2518	CB2016	CB2012			
CBC3225	CBC2518	CBC2016	CBC2012		
CBL2012					
CBMF1608					
LBM2016					

Inductance change: Within ±5% No significant abnormality in appearance.

**[Test Methods and Remarks]**

LEM :  
 Acceleration : 980m/sec<sup>2</sup>  
 Duration : 6msec  
 Number of times : 6 sides × 3 times  
 Mounting method : Soldering onto printed board  
 Recovery : At least 2 hrs of recovery under the standard condition after the test, followed by the measurement within 48 hrs.  
 LEM : Recovery  
 At least 1 hr of recovery under the standard condition after the test, followed by the measurement within 2 hrs.

15. Solderability					
LEM2520					
LB3218	LB2518	LB2016	LB2012	LB1608	LBMF1608
LBC3225	LBC2518	LBC2016	LBC2012		
LBR2518	LBR2012				
CB2518	CB2016	CB2012			
CBC3225	CBC2518	CBC2016	CBC2012		
CBL2012					
CBMF1608					
LBM2016					

At least 90% of surface of terminal electrode is covered by new

**[Test Methods and Remarks]**

LEM :  
 Solder temperature : 230±5°C  
 Duration : 5±0.5sec.  
 Flux : Methanol solution with 25% of colophony

LB · LBC · LBR · CB · CBC · CBL · LBM · LBMF · CBF :  
 Solder temperature : 245±5°C  
 Duration : 5±0.5sec  
 Flux : Methanol solution with 25% of colophony

\* This catalog contains the typical specification only due to the limitation of space. When you consider purchase of our products, please check our specification. For details of each product (characteristics graph, reliability information, precautions for use, and so on), see our Web site (<http://www.ty-top.com/>) or CD catalogs.

## RELIABILITY DATA

16. Resistance to soldering heat							
LEM2520							No significant abnormality in appearance.
LB3218	LB2518	LB2016	LB2012	LB1608	LBMF1608		LB3218, LB2518, LB2016, LB2012, LB1608 Inductance change: Within $\pm 10\%$ No significant abnormality in appearance. LBMF1608 Inductance change: Within $\pm 20\%$ No significant abnormality in appearance.
LBC3225	LBC2518	LBC2016	LBC2012				Inductance change: Within $\pm 10\%$ No significant abnormality in appearance.
LBR2518	LBR2012						
CB2518	CB2016	CB2012					
CBC3225	CBC2518	CBC2016	CBC2012				
CBL2012							
CBMF1608							Inductance change: Within $\pm 20\%$ No significant abnormality in appearance.
LBM2016							Inductance change: Within $\pm 5\%$ No significant abnormality in appearance.

**[Test Methods and Remarks]**

LEM :

Reflow condition 3 times of reflow over at  $220 \pm 5^\circ\text{C}$  for 40sec. MAX, With Peak temperature at  $240 \pm 5^\circ\text{C}$  for 5 sec. MAX. (Refer to a Profile of chart below.)

Flow condition

Solder temperature :  $260 \pm 5^\circ\text{C}$

Duration :  $10 \pm 1$  sec. Once

LB · LBC · LBR · CB · CBC · CBL · LBM · LBMF · CBF :

3 times of reflow oven at  $230^\circ\text{C}$  MIN for 40sec. with peak temperature at  $260^\circ\text{C}$  for 5sec.

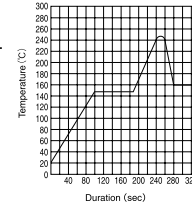

17. Resistance to solvent							
LEM2520							No significant abnormality in appearance
LB3218	LB2518	LB2016	LB2012	LB1608	LBMF1608		
LBC3225	LBC2518	LBC2016	LBC2012				
LBR2518	LBR2012						
CB2518	CB2016	CB2012					
CBC3225	CBC2518	CBC2016	CBC2012				
CBL2012							
CBMF1608							
LBM2016							

**[Test Methods and Remarks]**

Solvent temperature : Room temperature

Type of solvent : Isopropyl alcohol

(LEM2520 · LB · LBC · LBR · CB · CBC · CBL · LBM · LBMF · CBF)

Cleaning conditions : 90s. Immersion and cleaning.

(LEM2520 · LB · LBC · LBR · CB · CBC · CBL · LBM · LBMF · CBF)

18. Thermal shock							
LEM2520							Inductance change : Within $\pm 10\%$ Q → R12~4R7 : 30 min. 5R6~330 : 25 min. 390~820 : 20 min. 101 : 15 min.
LB3218	LB2518	LB2016	LB2012	LB1608	LBMF1608		Inductance change: Within $\pm 10\%$ No significant abnormality in appearance.
LBC3225	LBC2518	LBC2016	LBC2012				
LBR2518	LBR2012						
CB2518	CB2016	CB2012					
CBC3225	CBC2518	CBC2016	CBC2012				
CBL2012							
CBMF1608							
LBM2016							

**[Test Methods and Remarks]**

LEM : Conditions for 1 cycle

Step	Temperature (°C)	Duration (min)
1	-40	30
2	+85	30

Number of cycle : 100 cycle

Recovery : At least 1 hr of recovery under the standard condition after the test, followed by the measurement within 2 hrs.

LB · LBC · LBR · CB · CBC · CBL · LBM · LBMF · CBF :  $-40 \sim +85^\circ\text{C}$ , maintain times 30min., 100 cycle

Recovery : At least 2 hrs of recovery under the standard condition after the test, followed by the measurement within 48 hrs.

19. Damp heat							
LEM2520							Inductance change : Within $\pm 10\%$ Q → R12~4R7 : 30 min. 5R6~330 : 25 min. 390~820 : 20 min. 101 : 15 min.
LB3218	LB2518	LB2016	LB2012	LB1608	LBMF1608		Inductance change: Within $\pm 10\%$ No significant abnormality in appearance.
LBC3225	LBC2518	LBC2016	LBC2012				
LBR2518	LBR2012						
CB2518	CB2016	CB2012					
CBC3225	CBC2518	CBC2016	CBC2012				
CBL2012							
CBMF1608							
LBM2016							

**[Test Methods and Remarks]**

Temperature :  $60 \pm 2^\circ\text{C}$

Humidity : 90~95%RH

Duration : 1000 hrs

Recovery : At least 2 hrs of recovery under the standard condition after the test, followed by the measurement within 48 hrs.

LEM : Recovery

At least 1 hr of recovery under the standard condition after the test, followed by the measurement within 2 hrs.

\* This catalog contains the typical specification only due to the limitation of space. When you consider purchase of our products, please check our specification. For details of each product (characteristics graph, reliability information, precautions for use, and so on), see our Web site (<http://www.ty-top.com/>) or CD catalogs.

**RELIABILITY DATA**

**20.Loading under damp heat**

LEM2520						Inductance change :Within±10% Q→ R12~4R7 : 30 min. 5R6~330 : 25 min. 390~820 : 20 min. 101 : 15 min.	
LB3218	LB2518	LB2016	LB2012	LB1608	LBMF1608	Inductance change:Within±10%      No significant abnormality in appearance.	
LBC3225	LBC2518	LBC2016	LBC2012				
LBR2518	LBR2012						
CB2518	CB2016	CB2012					
CBC3225	CBC2518	CBC2016	CBC2012				
CBL2012							
CBMF1608							
LBM2016							
<b>[Test Methods and Remarks]</b> LEM·LB·LBC·LBR·CB·CBC·CBL·LBM·LBMF·CBMF : Temperature : 60±2°C Humidity : 90~95%RH Duration : 1000 hrs Applied current : Rated current Recovery : At least 2 hrs of recovery under the standard condition after the test, followed by the measurement within 48 hrs. LEM : Recovery At least 1 hr of recovery under the standard condition after the test, followed by the measurement within 2 hrs.							

**21.High temperature life test**

LEM2520						Inductance change :Within±10% Q→ R12~4R7 : 30 min. 5R6~330 : 25 min. 390~820 : 20 min. 101 : 15 min.	
LB3218	LB2518	LB2016	LB2012	LB1608	LBMF1608	Inductance change:Within±10%      No significant abnormality in appearance.	
LBC3225	LBC2518	LBC2016	LBC2012				
LBR2518	LBR2012						
CB2518	CB2016	CB2012					
CBC3225	CBC2518	CBC2016	CBC2012				
CBL2012							
CBMF1608							
LBM2016							
<b>[Test Methods and Remarks]</b> LEM·CB·CBC·CBL·LBM·CBMF : Temperature : 85±2°C Duration : 1000 hrs Recovery : At least 2 hrs of recovery under the standard condition after the test, followed by the measurement within 48 hrs. LEM : Recovery At least 1 hr of recovery under the standard condition after the test, followed by the measurement within 2 hrs.							

**22.Loading at high temperature**

LEM2520							
LB3218	LB2518	LB2016	LB2012	LB1608	LBMF1608	Inductance change:Within±10%      No significant abnormality in appearance.	
LBC3225	LBC2518	LBC2016	LBC2012				
LBR2518	LBR2012						
CB2518	CB2016	CB2012					
CBC3225	CBC2518	CBC2016	CBC2012				
CBL2012							
CBMF1608							
LBM2016							
<b>[Test Methods and Remarks]</b> LB·LBC·LBR·LBMF : Temperature : 85±2°C Duration : 1000 hrs Applied current : Rated current Recovery : At least 2 hrs of recovery under the standard condition after the test, followed by the measurement within 48 hrs.							

\* This catalog contains the typical specification only due to the limitation of space. When you consider purchase of our products, please check our specification. For details of each product (characteristics graph, reliability information, precautions for use, and so on), see our Web site (<http://www.ty-top.com/>) or CD catalogs.

## RELIABILITY DATA

### 23. Low temperature life test

LEM2520						Inductance change :Within±10% Q→ R12~4R7 : 30 min. 5R6~330 : 25 min. 390~820 : 20 min. 101 : 15 min.
LB3218	LB2518	LB2016	LB2012	LB1608	LBMF1608	Inductance change:Within±10%      No significant abnormality in appearance.
LBC3225	LBC2518	LBC2016	LBC2012			
LBR2518	LBR2012					
CB2518	CB2016	CB2012				
CBC3225	CBC2518	CBC2016	CBC2012			
CBL2012						
CBMF1608						
LBM2016						

#### [Test Methods and Remarks]

LEM · LB · LBC · LBR · CB · CBC · CBL · LBM · LBMF · CBF

Temperature : -40±2℃

Duration : 1000 hrs

Recovery : At least 2 hrs of recovery under the standard condition after the test, followed by the measurement within 48 hrs.

LEM : Recovery

At least 1 hr of recovery under the standard condition after the test, followed by the measurement within 2 hrs.

### 24. Standard condition

LEM2520						Standard test conditions Unless specified, Ambient temperature is 20±15℃ and the Relative humidity is 65±20%. If there is any doubt about the test results, further measurement shall be had within the following limits: Ambient Temperature: 20±2℃ Relative humidity: 65±5% Inductance value is based on our standard measurement systems.
LB3218	LB2518	LB2016	LB2012	LB1608	LBMF1608	
LBC3225	LBC2518	LBC2016	LBC2012			
LBR2518	LBR2012					
CB2518	CB2016	CB2012				
CBC3225	CBC2518	CBC2016	CBC2012			
CBL2012						
CBMF1608						
LBM2016						

\* This catalog contains the typical specification only due to the limitation of space. When you consider purchase of our products, please check our specification.  
For details of each product (characteristics graph, reliability information, precautions for use, and so on), see our Web site (<http://www.ty-top.com/>) or CD catalogs.

## PRECAUTIONS

### LEM Type, LB Type, CB Type

#### 1. Circuit Design

Precautions	<p>◆Operating environment</p> <p>1. The products described in this specification are intended for use in general electronic equipment,(office supply equipment, telecommunications systems, measuring equipment, and household equipment). They are not intended for use in mission-critical equipment or systems requiring special quality and high reliability (traffic systems, safety equipment, aerospace systems, nuclear control systems and medical equipment including life-support systems,) where product failure might result in loss of life, injury or damage. For such uses, contact TAIYO YUDEN Sales Department in advance.</p>
-------------	--

#### 2. PCB Design

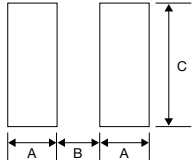
Precautions	<p>◆Land pattern design</p> <p>1. Please contact any of our offices for a land pattern, and refer to a recommended land pattern of a right figure or specifications.</p>																																								
Technical considerations	<p>PRECAUTIONS [Recommended Land Patterns] Surface Mounting</p> <ul style="list-style-type: none"> <li>Mounting and soldering conditions should be checked beforehand.</li> <li>Applicable soldering process to those products is reflow soldering only.</li> <li>Recommended Land Patterns</li> </ul>  <table border="1" style="margin-left: auto; margin-right: auto;"> <thead> <tr> <th colspan="4">Unit : mm</th> </tr> <tr> <th>TYPE</th> <th>A</th> <th>B</th> <th>C</th> </tr> </thead> <tbody> <tr> <td>1608</td> <td>0.55</td> <td>0.7</td> <td>1.0</td> </tr> <tr> <td>MF1608</td> <td>0.55</td> <td>0.8</td> <td>0.9</td> </tr> <tr> <td>2012</td> <td>0.7</td> <td>0.8</td> <td>1.45</td> </tr> <tr> <td>2016</td> <td>0.7</td> <td>0.8</td> <td>1.8</td> </tr> <tr> <td>2518</td> <td>0.8</td> <td>1.2</td> <td>2.0</td> </tr> <tr> <td>LEM2520</td> <td>0.9</td> <td>1.5</td> <td>1.5</td> </tr> <tr> <td>3218</td> <td>1.0</td> <td>1.6</td> <td>2.0</td> </tr> <tr> <td>3225</td> <td>1.0</td> <td>1.6</td> <td>2.7</td> </tr> </tbody> </table>	Unit : mm				TYPE	A	B	C	1608	0.55	0.7	1.0	MF1608	0.55	0.8	0.9	2012	0.7	0.8	1.45	2016	0.7	0.8	1.8	2518	0.8	1.2	2.0	LEM2520	0.9	1.5	1.5	3218	1.0	1.6	2.0	3225	1.0	1.6	2.7
Unit : mm																																									
TYPE	A	B	C																																						
1608	0.55	0.7	1.0																																						
MF1608	0.55	0.8	0.9																																						
2012	0.7	0.8	1.45																																						
2016	0.7	0.8	1.8																																						
2518	0.8	1.2	2.0																																						
LEM2520	0.9	1.5	1.5																																						
3218	1.0	1.6	2.0																																						
3225	1.0	1.6	2.7																																						

#### 3. Considerations for automatic placement

Precautions	<p>◆Adjustment of mounting machine</p> <p>1. Excessive impact load should not be imposed on the products when mounting onto the PC boards.</p> <p>2. Mounting and soldering conditions should be checked beforehand.</p>
Technical considerations	<p>1. When installing products, care should be taken not to apply distortion stress as it may deform the products.</p>

#### 4. Soldering

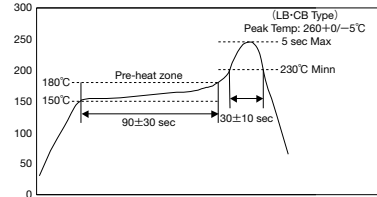
Precautions	<p>◆Wave soldering (LEM Type only)</p> <p>1. For wave soldering, please apply conditions meeting the range of the specified conditions in our catalog or the relevant specifications.</p> <p>◆Reflow soldering (LB and CB Types)</p> <p>1. For reflow soldering with either leaded or lead-free solder, the profile specified in "point for controlling" is recommended.</p> <p>◆Reflow soldering (LEM)</p> <p>1. For reflow soldering, please apply conditions meeting the range of the specified conditions in our catalog or the relevant specifications.</p> <p>◆Recommended conditions for using a soldering iron</p> <p>1. Put the soldering iron on the land-pattern. Soldering iron's temperature-Below 350°C Duration-3 seconds or less. The soldering iron should not come in contact with inductor directly.</p>
Technical considerations	<p>◆Wave soldering (LEM Type only)</p> <p>1. Components can be damaged by excessive heat where soldering conditions exceed the specified range.</p> <p>◆Reflow soldering (LB and CB Types)</p> <p>1. Reflow profile</p>  <p>◆Recommended conditions for using a soldering iron</p> <p>1. Components can be damaged by excessive heat where soldering conditions exceed the specified range.</p>

#### 5. Cleaning

Precautions	<p>◆Cleaning conditions</p> <p>1. LEM Type, LB Type, CB Type Washing by supersonic waves shall be avoided.</p>
Technical considerations	<p>◆Cleaning conditions</p> <p>1. LEM Type, LB Type, CB Type If washing by supersonic waves, supersonic waves may cause broken products.</p>

#### 6. Handling

Precautions	<p>◆Handling</p> <p>1. Keep the inductors away from all magnets and magnetic objects.</p> <p>◆Breakaway PC boards (splitting along perforations)</p> <p>1. When splitting the PC board after mounting inductors, care should be taken not to give any stresses of deflection or twisting to the board.</p> <p>2. Board separation should not be done manually, but by using the appropriate devices.</p> <p>◆Mechanical considerations</p> <p>1. Please do not give the inductors any excessive mechanical shocks.</p>
Technical considerations	<p>◆Handling</p> <p>1. There is a case that a characteristic varies with magnetic influence.</p> <p>◆Breakaway PC boards (splitting along perforations)</p> <p>1. Planning pattern configurations and the position of products should be carefully performed to minimize stress.</p> <p>◆Mechanical considerations</p> <p>1. There is a case to be damaged by a mechanical shock.</p>

#### 7. Storage conditions

Precautions	<p>◆Storage</p> <p>1. To maintain the solderability of terminal electrodes and to keep the packing material in good condition, temperature and humidity in the storage area should be controlled.</p> <ul style="list-style-type: none"> <li>Recommended conditions</li> <li>Ambient temperature : 0~40°C / Humidity : Below 70% RH</li> </ul> <p>The ambient temperature must be kept below 30°C Even under ideal storage conditions, solderability of products electrodes may decrease as time passes. For this reason, LE type inductors should be used within one year from the time of delivery.</p> <p>LB type : Should be used within 6 months from the time of delivery.</p> <p>LE type : In case of storage over 6 months, solderability shall be checked before actual usage.</p>
Technical considerations	<p>◆Storage</p> <p>1. Under a high temperature and humidity environment, problems such as reduced solderability caused by oxidation of terminal electrodes and deterioration of taping/packaging materials may take place.</p>

\* This catalog contains the typical specification only due to the limitation of space. When you consider purchase of our products, please check our specification. For details of each product (characteristics graph, reliability information, precautions for use, and so on), see our Web site (<http://www.ty-top.com/>) or CD catalogs.

# SMD INDUCTORS LOW PROFILE TYPE



REFLOW

## FEATURES

- Small and Low profile inductor.
- It corresponds to High current.
- Simple and original magnetic shield structure.
- Durable structure against dropping impact.

## APPLICATIONS

- For small DC/DC converter (cellular Phone, HDD, DVC, DSC, PDA, LCD display etc).

## ORDERING CODE

NR△ 4 0 1 8 T △ 1 0 0 M △

① Type: NR△, NRG | Coating resin specification △=Blank Space

② External dimensions (W×L×H)

example	4026		4.0×4.0×2.6mm	
3010	3.0×3.0×1.0mm	5040	5.0×5.0×4.0mm	
3012	3.0×3.0×1.2mm	6012	6.0×6.0×1.2mm	
3015	3.0×3.0×1.5mm	6020	6.0×6.0×2.0mm	
4010	4.0×4.0×1.0mm	6028	6.0×6.0×2.8mm	
4012	4.0×4.0×1.2mm	6045	6.0×6.0×4.5mm	
4018	4.0×4.0×1.8mm	8040	8.0×8.0×4.0mm	

③ Packaging: T△ | Tape & Reel △=Blank Space

④ Nominal inductance [ $\mu$ H]

example	
2R2	2.2
100	10
101	100

※R=decimal point

⑤ Inductance tolerance

M	±20%
N	±30%

⑥ Internal code: △ | Standard product △=Blank Space

## EXTERNAL DIMENSIONS/STANDARD QUANTITY

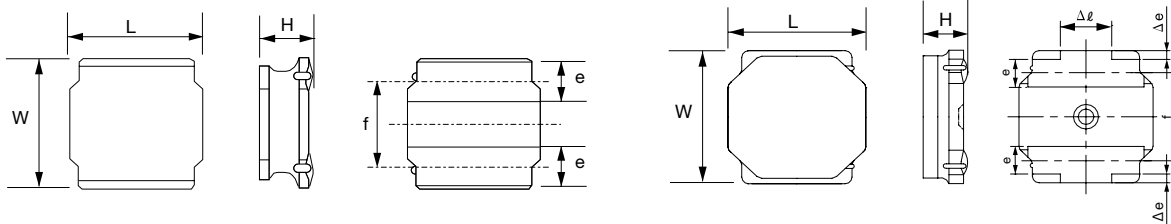

Type	L	W	H	e	f	Standard Quantity [pcs] Tape & Reel
NR3010	3.0±0.1 (0.118±0.004)	3.0±0.1 (0.118±0.004)	1.0 max (0.039 max)	0.9±0.2 (0.035±0.008)	1.9±0.2 (0.075±0.008)	2000
NR3012			1.2 max (0.047 max)			
NR3015			1.5 max (0.059 max)			
NR4010	4.0±0.2 (0.157±0.008)	4.0±0.2 (0.157±0.008)	1.0 max (0.039 max)	1.1±0.2 (0.043±0.008)	2.5±0.2 (0.098±0.008)	5000
NR4012			1.2 max (0.047 max)			4500
NR4018			1.8 max (0.071 max)			3500
NRG4026			2.6 max (0.102 max)			2000
NR8040	8.0±0.2 (0.315±0.008)	8.0±0.2 (0.315±0.008)	<sup>+1)</sup> 4.2max (0.165max) <sup>+2)</sup> 4.0max (0.157max)	1.6±0.3 (0.063±0.012)	5.6±0.3 (0.220±0.012)	1000

\*1) 0R9~6R8 Type  
\*2) 100~101 Type

Unit : mm (inch)

Type	L	W	H	e	Δe	f	Δφ	Standard Quantity [pcs] Tape & Reel
NR5040	4.9±0.2 (0.193±0.008)	4.9±0.2 (0.193±0.008)	<sup>+3)</sup> 4.1max (0.161max) <sup>+4)</sup> 4.0max (0.157max)	1.2±0.2 (0.047±0.008)	0.3±0.2 (0.011±0.008)	3.3±0.2 (0.130±0.008)	1.3±0.3 (0.051±0.011)	1500
NR6012 (E Type)	6.0±0.2 (0.236±0.008)	6.0±0.2 (0.236±0.008)	1.2 max (0.047 max)	1.35±0.2 (0.053±0.008)	0.3±0.2 (0.011±0.008)	4.0±0.2 (0.157±0.008)	2.3±0.3 (0.091±0.011)	1000
NR6020	6.0±0.2 (0.236±0.008)	6.0±0.2 (0.236±0.008)	2.0 max (0.078 max)	1.35±0.2 (0.053±0.008)	0.3±0.2 (0.011±0.008)	4.0±0.2 (0.157±0.008)		2500
NR6028	6.0±0.2 (0.236±0.008)	6.0±0.2 (0.236±0.008)	2.8 max (0.110 max)	1.35±0.2 (0.053±0.008)	0.3±0.2 (0.011±0.008)	4.0±0.2 (0.157±0.008)		2000
NR6045	6.0±0.2 (0.236±0.008)	6.0±0.2 (0.236±0.008)	4.5 max (0.177 max)	1.35±0.2 (0.053±0.008)	0.3±0.2 (0.011±0.008)	4.0±0.2 (0.157±0.008)		1500

\*3) 1R5~100 Type

\*4) 150~470 Type

Unit : mm (inch)

\* This catalog contains the typical specification only due to the limitation of space. When you consider purchase of our products, please check our specification. For details of each product (characteristics graph, reliability information, precautions for use, and so on), see our Web site (<http://www.ty-top.com/>) or CD catalogs.

Recommended Land Patterns

[NR3010, NR3012, NR3015]

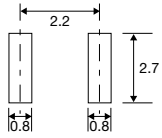

[NR4010, NR4012, NR4018, NRG4026]

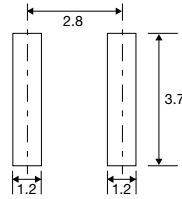

[NR5040]

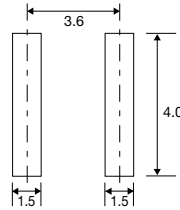

[NR6012, NR6020, NR6028, NR6045]

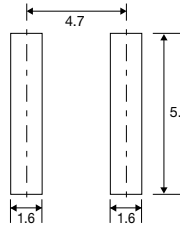

[NR8040]

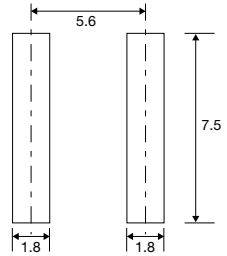

Unit : mm

AVAILABLE INDUCTANCE RANGE

Range	Type	NR 3010		NR 3012		NR 3015		NR 4010		NR 4012		NR 4018		NR 5040		NR 6012		NR 6020		NR 6028		NR 6045		NR 8040		NRG 4026		
		IMAX [mA]	Rdc±20% [Ω]	IMAX [mA]	Rdc±20% [Ω]	IMAX [mA]	Rdc±20% [Ω]	IMAX [mA]	Rdc±20% [Ω]	IMAX [mA]	Rdc±20% [Ω]	IMAX [mA]	Rdc±20% [Ω]	IMAX [mA]	Rdc±20% [Ω]	IMAX [mA]	Rdc±20% [Ω]	IMAX [mA]	Rdc±20% [Ω]	IMAX [mA]	Rdc±20% [Ω]	IMAX [mA]	Rdc±20% [Ω]	IMAX [mA]	Rdc±20% [Ω]	IMAX [mA]	Rdc±20% [Ω]	
0.8		1300	0.065	1490	0.05	2100	0.030	1050	0.100	1500	0.060	1830	0.030															
3.3														3600	0.020													
10		500	0.450	540	0.290	700	0.230	560	0.380	740	0.240	840	0.180	2100	0.056	1000	0.235	1400	0.125	1900	0.065	2500	0.047	3100	0.034	1300	0.085	
47		220	2.05	250	1.45	300	1.34	240	1.81	350	1.00			900	0.310			950	0.290									
100												170	4.00			320	2.18			620	6.000	700	5.000	1000	0.290			
220																												

PART NUMBERS

NR 3010 Shielded type

Ordering code	EHS (Environmental Hazardous Substances)	Inductance [μH]	Inductance Tolerance	Self-resonant frequency [MHz] (min.)	DC Resistance [Ω] (±20%)	Rated current ※) [mA]		Measuring frequency [kHz]
						Saturation current I <sub>dc1</sub>	Temperature rise current I <sub>dc2</sub>	
NR 3010T 1R0N	RoHS	1.0	±30%	126	0.065	1,300	1,400	100
NR 3010T 1R5N	RoHS	1.5		98	0.080	1,200	1,300	
NR 3010T 2R2M	RoHS	2.2		82	0.095	1,100	1,100	
NR 3010T 3R3M	RoHS	3.3	63	0.140	870	940		
NR 3010T 4R7M	RoHS	4.7	56	0.190	750	780		
NR 3010T 6R8M	RoHS	6.8	46	0.300	610	630		
NR 3010T 100M	RoHS	10	35	0.450	500	510		
NR 3010T 150M	RoHS	15	30	0.740	400	400		
NR 3010T 220M	RoHS	22	25	1.03	350	350		
NR 3010T 330M	RoHS	33	20	1.55	260	275		
NR 3010T 470M	RoHS	47	17	2.05	220	235		

NR 3012 Shielded type

Ordering code	EHS (Environmental Hazardous Substances)	Inductance [μH]	Inductance Tolerance	Self-resonant frequency [MHz] (min.)	DC Resistance [Ω] (±20%)	Rated current ※) [mA]		Measuring frequency [kHz]
						Saturation current I <sub>dc1</sub>	Temperature rise current I <sub>dc2</sub>	
NR 3012T 1R0N	RoHS	1.0	±30%	110	0.050	1,500	1,490	100
NR 3012T 1R5N	RoHS	1.5		92	0.060	1,360	1,400	
NR 3012T 2R2M	RoHS	2.2		70	0.080	1,100	1,200	
NR 3012T 3R3M	RoHS	3.3	55	0.100	910	1,050		
NR 3012T 4R7M	RoHS	4.7	48	0.130	770	980		
NR 3012T 6R8M	RoHS	6.8	40	0.190	670	740		
NR 3012T 100M	RoHS	10	32	0.290	540	630		
NR 3012T 150M	RoHS	15	27	0.450	440	485		
NR 3012T 220M	RoHS	22	22	0.630	375	420		
NR 3012T 330M	RoHS	33	19	1.03	310	330		
NR 3012T 470M	RoHS	47	17	1.45	250	280		

NR 3015 Shielded type

Ordering code	EHS (Environmental Hazardous Substances)	Inductance [μH]	Inductance Tolerance	Self-resonant frequency [MHz] (min.)	DC Resistance [Ω] (±20%)	Rated current ※) [mA]		Measuring frequency [kHz]
						Saturation current I <sub>dc1</sub>	Temperature rise current I <sub>dc2</sub>	
NR 3015T 1R0N	RoHS	1.0	±30%	100	0.030	2,100	2,100	100
NR 3015T 1R5N	RoHS	1.5		87	0.040	1,800	1,820	
NR 3015T 2R2M	RoHS	2.2		64	0.060	1,480	1,500	
NR 3015T 3R3M	RoHS	3.3	49	0.080	1,210	1,230		
NR 3015T 4R7M	RoHS	4.7	40	0.120	1,020	1,040		
NR 3015T 6R8M	RoHS	6.8	36	0.160	870	880		
NR 3015T 100M	RoHS	10	28	0.230	700	710		
NR 3015T 150M	RoHS	15	23	0.360	560	560		
NR 3015T 220M	RoHS	22	20	0.520	470	470		
NR 3015T 330M	RoHS	33	18	0.840	390	370		
NR 3015T 470M	RoHS	47	17	1.34	320	300		

※) The saturation current value (I<sub>dc1</sub>) is the DC current value having inductance decrease down to 30%. (at 20°C)

※) The temperature rise current value (I<sub>dc2</sub>) is the DC current value having temperature increase up to 40°C. (at 20°C)

※) The rated current is the DC current value that satisfies both of current value saturation current value and temperature rise current value.

\* This catalog contains the typical specification only due to the limitation of space. When you consider purchase of our products, please check our specification. For details of each product (characteristics graph, reliability information, precautions for use, and so on), see our Web site (<http://www.ty-top.com/>) or CD catalogs.



**PART NUMBERS**

● NR 4010 Shielded type

Ordering code	EHS (Environmental Hazardous Substances)	Inductance [ $\mu$ H]	Inductance Tolerance	Self-resonant frequency [MHz] (min.)	DC Resistance [ $\Omega$ ] ( $\pm 20\%$ )	Rated current ※) [mA]		Measuring frequency [kHz]
						Saturation current Idc1	Temperature rise current Idc2	
NR 4010T 1R0N	RoHS	1.0	$\pm 30\%$	116	0.100	1,800	1,050	100
NR 4010T 2R2N	RoHS	2.2		73	0.150	1,150	890	
NR 4010T 3R3M	RoHS	3.3		58	0.180	1,100	820	
NR 4010T 4R7M	RoHS	4.7	$\pm 20\%$	47	0.210	900	750	
NR 4010T 6R8M	RoHS	6.8		38	0.300	740	620	
NR 4010T 100M	RoHS	10		31	0.380	560	600	
NR 4010T 150M	RoHS	15		24	0.510	470	510	
NR 4010T 220M	RoHS	22		19	0.870	360	400	
NR 4010T 330M	RoHS	33		15	1.54	280	300	
NR 4010T 470M	RoHS	47		13	1.81	240	280	

● NR 4012 Shielded type

Ordering code	EHS (Environmental Hazardous Substances)	Inductance [ $\mu$ H]	Inductance Tolerance	Self-resonant frequency [MHz] (min.)	DC Resistance [ $\Omega$ ] ( $\pm 20\%$ )	Rated current ※) [mA]		Measuring frequency [kHz]
						Saturation current Idc1	Temperature rise current Idc2	
NR 4012T 1R0N	RoHS	1.0	$\pm 30\%$	131	0.060	2,500	1,500	100
NR 4012T 2R2M	RoHS	2.2		66	0.090	1,650	1,200	
NR 4012T 3R3M	RoHS	3.3		50	0.130	1,200	980	
NR 4012T 4R7M	RoHS	4.7	$\pm 20\%$	45	0.140	1,050	960	
NR 4012T 6R8M	RoHS	6.8		35	0.180	900	840	
NR 4012T 100M	RoHS	10		28	0.240	740	770	
NR 4012T 150M	RoHS	15		23	0.400	560	600	
NR 4012T 220M	RoHS	22		18	0.480	510	540	
NR 4012T 330M	RoHS	33		15	0.810	400	420	
NR 4012T 470M	RoHS	47		12	1.00	350	370	

● NR 4018 Shielded type

Ordering code	EHS (Environmental Hazardous Substances)	Inductance [ $\mu$ H]	Inductance Tolerance	Self-resonant frequency [MHz] (min.)	DC Resistance [ $\Omega$ ] ( $\pm 20\%$ )	Rated current ※) [mA]		Measuring frequency [kHz]
						Saturation current Idc1	Temperature rise current Idc2	
NR 4018T 1R0N	RoHS	1.0	$\pm 30\%$	80	0.030	4,000	1,830	100
NR 4018T 2R2M	RoHS	2.2		52	0.060	2,700	1,440	
NR 4018T 3R3M	RoHS	3.3		44	0.070	2,000	1,230	
NR 4018T 4R7M	RoHS	4.7	$\pm 20\%$	34	0.090	1,700	1,200	
NR 4018T 6R8M	RoHS	6.8		29	0.110	1,450	1,060	
NR 4018T 100M	RoHS	10		24	0.180	1,200	840	
NR 4018T 150M	RoHS	15		19	0.250	940	650	
NR 4018T 220M	RoHS	22		16	0.360	800	590	
NR 4018T 330M	RoHS	33		12	0.530	650	490	
NR 4018T 470M	RoHS	47		10	0.650	570	420	
NR 4018T 680M	RoHS	68		8.3	1.00	470	320	
NR 4018T 101M	RoHS	100		6.5	1.50	400	270	
NR 4018T 151M	RoHS	150		5.5	2.50	310	220	
NR 4018T 221M	RoHS	220	4.0	4.00	270	170		

● NR 5040 Shielded type

Ordering code	EHS (Environmental Hazardous Substances)	Inductance [ $\mu$ H]	Inductance Tolerance	Self-resonant frequency [MHz] (min.)	DC Resistance [ $\Omega$ ] ( $\pm 30\%$ )	Rated current ※) [mA]		Measuring frequency [kHz]
						Saturation current Idc1	Temperature rise current Idc2	
NR 5040T 1R5N	RoHS	1.5	$\pm 30\%$	60	0.020	6,000	3,600	100
NR 5040T 2R2N	RoHS	2.2		42	0.022	4,600	3,500	
NR 5040T 3R3N	RoHS	3.3		32	0.027	3,800	3,300	
NR 5040T 4R7N	RoHS	4.7	$\pm 20\%$	28	0.029	3,300	3,100	
NR 5040T 6R8M	RoHS	6.8		21	0.049	2,600	2,300	
NR 5040T 100M	RoHS	10		18	0.056	2,300	2,100	
NR 5040T 150M	RoHS	15		13	0.080	2,000	1,800	
NR 5040T 220M	RoHS	22		9	0.126	1,600	1,400	
NR 5040T 330M	RoHS	33		7	0.180	1,300	1,200	
NR 5040T 470M	RoHS	47		6	0.310	1,100	900	

● NR 6012 Shielded type

Ordering code	EHS (Environmental Hazardous Substances)	Inductance [ $\mu$ H]	Inductance Tolerance	Self-resonant frequency [MHz] (min.)	DC Resistance [ $\Omega$ ] ( $\pm 20\%$ )	Rated current ※) [mA]		Measuring frequency [kHz]
						Saturation current Idc1	Temperature rise current Idc2	
NR 6012T 2R5NE	RoHS	2.5	$\pm 30\%$	45	0.090	2,100	1,730	100
NR 6012T 4R0NE	RoHS	4.0		39	0.105	1,800	1,570	
NR 6012T 5R3ME	RoHS	5.3		34	0.125	1,500	1,400	
NR 6012T 6R8ME	RoHS	6.8	$\pm 20\%$	30	0.165	1,300	1,180	
NR 6012T 100ME	RoHS	10		22	0.235	1,000	1,000	
NR 6012T 150ME	RoHS	15		18	0.330	800	790	
NR 6012T 220ME	RoHS	22		12	0.530	760	630	
NR 6012T 330ME	RoHS	33		8	0.700	590	530	
NR 6012T 470ME	RoHS	47		6	1.05	520	460	
NR 6012T 680ME	RoHS	68		3	1.35	440	410	
NR 6012T 101ME	RoHS	100	1	2.18	350	320		

※) The saturation current value (Idc1) is the DC current value having inductance decrease down to 30%. (at 20°C)

※) The temperature rise current value (Idc2) is the DC current value having temperature increase up to 40°C. (at 20°C)

※) The rated current is the DC current value that satisfies both of current value saturation current value and temperature rise current value.

\* This catalog contains the typical specification only due to the limitation of space. When you consider purchase of our products, please check our specification. For details of each product (characteristics graph, reliability information, precautions for use, and so on), see our Web site (<http://www.ty-top.com/>) or CD catalogs.

## PART NUMBERS

### ● NR 6020 Shielded type

Ordering code	EHS (Environmental Hazardous Substances)	Inductance [ $\mu$ H]	Inductance Tolerance	Self-resonant frequency [MHz] (min.)	DC Resistance [ $\Omega$ ] ( $\pm 20\%$ )	Rated current ※) [mA]		Measuring frequency [kHz]
						Saturation current I <sub>dc1</sub>	Temperature rise current I <sub>dc2</sub>	
NR 6020T 0R8N	RoHS	0.8	$\pm 30\%$	110	0.020	5,500	3,800	100
NR 6020T 1R5N	RoHS	1.5		93	0.026	4,000	3,200	
NR 6020T 2R2N	RoHS	2.2		73	0.034	3,200	2,700	
NR 6020T 3R3N	RoHS	3.3		55	0.040	2,800	2,600	
NR 6020T 4R7N	RoHS	4.7		43	0.058	2,400	2,000	
NR 6020T 6R8N	RoHS	6.8	$\pm 20\%$	30	0.085	2,000	1,800	
NR 6020T 100M	RoHS	10		18	0.125	1,700	1,400	
NR 6020T 220M	RoHS	22		11	0.290	1,050	950	

### ● NR 6028 Shielded type

Ordering code	EHS (Environmental Hazardous Substances)	Inductance [ $\mu$ H]	Inductance Tolerance	Self-resonant frequency [MHz] (min.)	DC Resistance [ $\Omega$ ] ( $\pm 30\%$ )	Rated current ※) [mA]		Measuring frequency [kHz]
						Saturation current I <sub>dc1</sub>	Temperature rise current I <sub>dc2</sub>	
NR 6028T 0R9N	RoHS	0.9	$\pm 30\%$	90	0.013	6,600	4,600	100
NR 6028T 1R5N	RoHS	1.5		78	0.016	5,000	4,200	
NR 6028T 2R2N	RoHS	2.2		68	0.020	4,200	3,700	
NR 6028T 3R0N	RoHS	3.0		55	0.023	3,600	3,400	
NR 6028T 4R7M	RoHS	4.7		39	0.031	2,700	3,000	
NR 6028T 6R0M	RoHS	6.0	$\pm 20\%$	30	0.040	2,500	2,500	
NR 6028T 100M	RoHS	10		20	0.065	1,900	1,900	
NR 6028T 150M	RoHS	15		17	0.095	1,600	1,800	
NR 6028T 220M	RoHS	22		12	0.135	1,300	1,400	
NR 6028T 330M	RoHS	33		10	0.220	1,100	1,100	
NR 6028T 470M	RoHS	47		8	0.300	950	920	
NR 6028T 680M	RoHS	68		5	0.420	760	770	
NR 6028T 101M	RoHS	100		3	0.600	620	660	

### ● NR 6045 Shielded type

Ordering code	EHS (Environmental Hazardous Substances)	Inductance [ $\mu$ H]	Inductance Tolerance	Self-resonant frequency [MHz] (min.)	DC Resistance [ $\Omega$ ] ( $\pm 30\%$ )	Rated current ※) [mA]		Measuring frequency [kHz]
						Saturation current I <sub>dc1</sub>	Temperature rise current I <sub>dc2</sub>	
NR 6045T 1R0N	RoHS	1.0	$\pm 30\%$	110	0.014	8,500	4,200	100
NR 6045T 1R3N	RoHS	1.3		95	0.016	8,000	4,000	
NR 6045T 1R8N	RoHS	1.8		80	0.018	7,000	3,700	
NR 6045T 2R3N	RoHS	2.3		60	0.021	6,000	3,500	
NR 6045T 3R0N	RoHS	3.0		45	0.024	5,000	3,200	
NR 6045T 4R5M	RoHS	4.5	$\pm 20\%$	25	0.031	4,000	3,000	
NR 6045T 6R3M	RoHS	6.3		15	0.038	3,800	2,800	
NR 6045T 100M	RoHS	10		12	0.047	3,000	2,500	
NR 6045T 150M	RoHS	15		10	0.077	2,300	1,900	
NR 6045T 220M	RoHS	22		7	0.115	1,900	1,500	
NR 6045T 330M	RoHS	33		6	0.145	1,500	1,400	
NR 6045T 470M	RoHS	47		5	0.220	1,300	1,100	
NR 6045T 680M	RoHS	68		4	0.330	1,000	900	
NR 6045T 101M	RoHS	100		3	0.500	800	700	

### ● NR 8040 Shielded type

Ordering code	EHS (Environmental Hazardous Substances)	Inductance [ $\mu$ H]	Inductance Tolerance	Self-resonant frequency [MHz] (min.)	DC Resistance [ $\Omega$ ] ( $\pm 30\%$ )	Rated current ※) [mA]		Measuring frequency [kHz]
						Saturation current I <sub>dc1</sub>	Temperature rise current I <sub>dc2</sub>	
NR 8040T 0R9N	RoHS	0.9	$\pm 30\%$	85	0.006	11,000	7,800	100
NR 8040T 1R4N	RoHS	1.4		63	0.007	9,000	7,000	
NR 8040T 2R0N	RoHS	2.0		50	0.009	7,400	6,300	
NR 8040T 3R6N	RoHS	3.6		34	0.015	5,300	4,900	
NR 8040T 4R7N	RoHS	4.7		30	0.018	4,700	4,100	
NR 8040T 6R8N	RoHS	6.8		24	0.025	4,000	3,700	
NR 8040T 100M	RoHS	10		22	0.034	3,400	3,100	
NR 8040T 150M	RoHS	15	$\pm 20\%$	16	0.050	2,700	2,400	
NR 8040T 220M	RoHS	22		13	0.066	2,200	2,200	
NR 8040T 330M	RoHS	33		12	0.100	1,900	1,700	
NR 8040T 470M	RoHS	47		8	0.150	1,500	1,400	
NR 8040T 680M	RoHS	68		7	0.230	1,200	1,100	
NR 8040T 101M	RoHS	100		6	0.290	1,000	1,000	

\* This catalog contains the typical specification only due to the limitation of space. When you consider purchase of our products, please check our specification. For details of each product (characteristics graph, reliability information, precautions for use, and so on), see our Web site (<http://www.ty-top.com/>) or CD catalogs.

■ PART NUMBERS

● NRG 4026 Shielded type

Ordering code	Inductance [ $\mu$ H]	Inductance Tolerance	Self-resonant frequency (MHz) (min.)	DC Resistance [ $\Omega$ ] ( $\pm$ 30%)	Rated current ※) (mA)		Measuring frequency (kHz)
					Saturation current Idc1	Temperature rise current Idc2	
NRG4026 T 1R2N	1.2	$\pm$ 30%	120	0.030	3,100	2,300	100
NRG4026 T 2R3N	2.3		96	0.040	2,100	1,970	
NRG4026 T 3R5M	3.5		58	0.050	1,800	1,700	
NRG4026 T 4R7M	4.7	$\pm$ 20%	46	0.055	1,450	1,600	
NRG4026 T 6R6M	6.6		33	0.065	1,300	1,500	
NRG4026 T 100M	10		26	0.085	1,000	1,300	
NRG4026 T 150M	15		19	0.110	900	1,100	
NRG4026 T 220M	22		13	0.165	610	900	
NRG4026 T 330M	33		9	0.200	540	800	
NRG4026 T 470M	47		6	0.300	410	650	

※) The saturation current (Idc1) is DC current value Inductance decrease down to 30%. (at 20°C)

※) The temperature rise current value (Idc2) is the DC current value having temperature increase up to 40°C. (at 20°C)

※) The rated current is Idc2.

\* This catalog contains the typical specification only due to the limitation of space. When you consider purchase of our products, please check our specification.  
For details of each product (characteristics graph, reliability information, precautions for use, and so on), see our Web site (<http://www.ty-top.com/>) or CD catalogs.

DC Bias characteristics

(Measured by HP4285A)

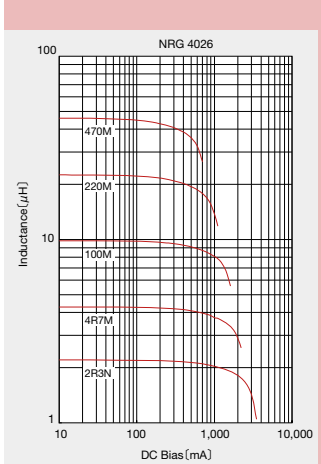
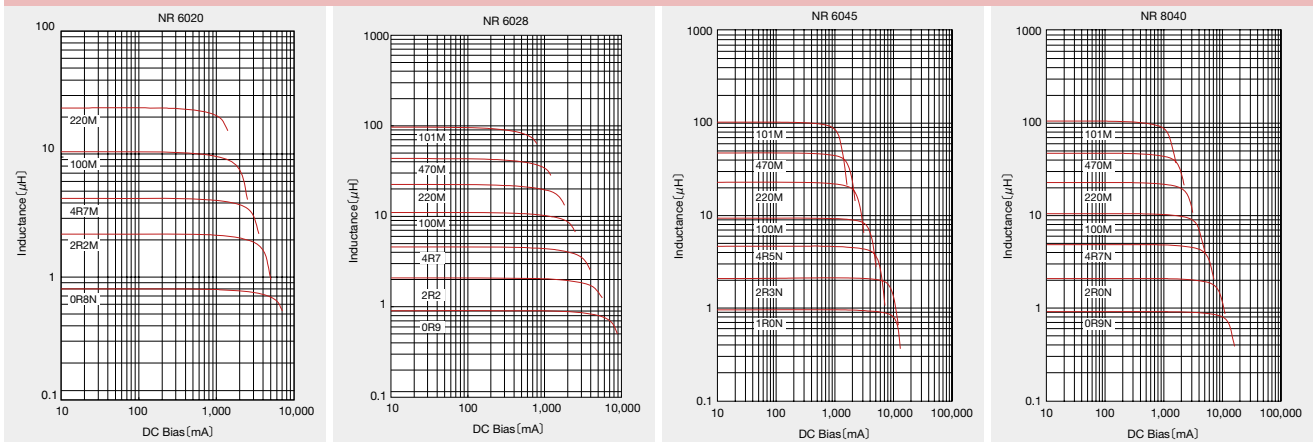
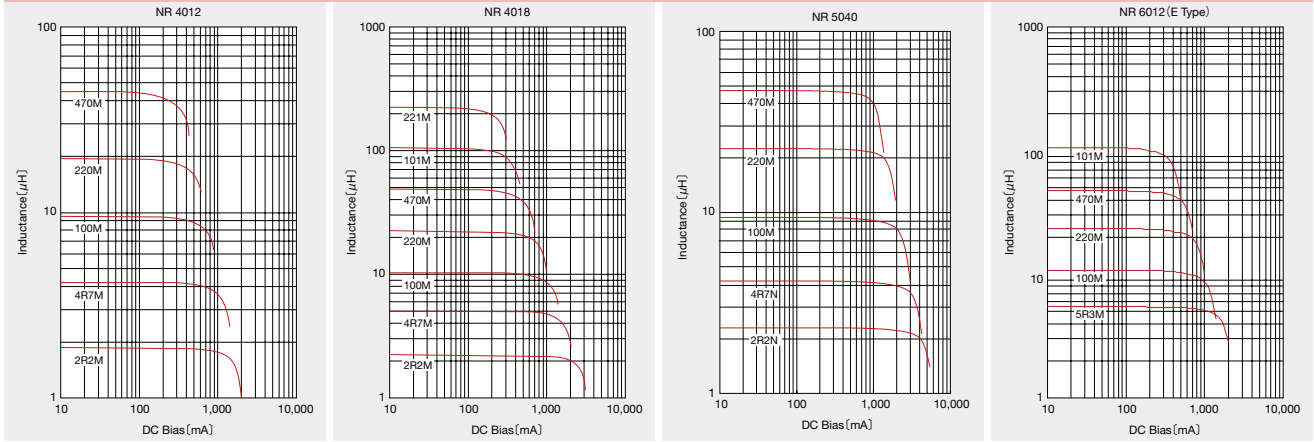
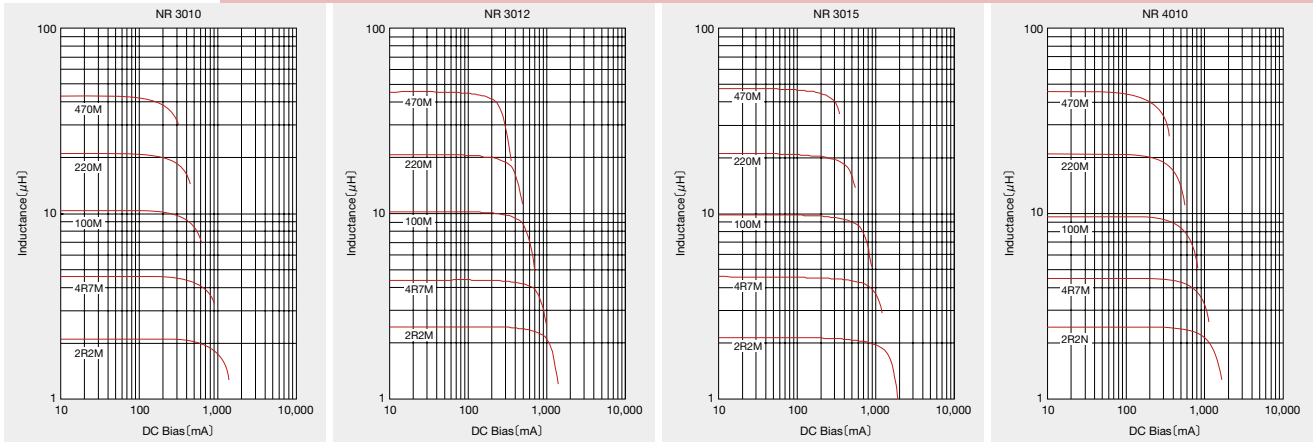

\* This catalog contains the typical specification only due to the limitation of space. When you consider purchase of our products, please check our specification. For details of each product (characteristics graph, reliability information, precautions for use, and so on), see our Web site (<http://www.ty-top.com/>) or CD catalogs.

# SMD INDUCTORS SMALL AND LARGE CURRENT TYPE



REFLOW

## FEATURES

- Small and Low profile inductor.
- It corresponds to High current.
- Simple and original magnetic shield structure.
- Durable structure against dropping impact.

## APPLICATIONS

- For small DC/DC converter (cellular Phone, HDD, DVC, DSC, PDA, LCD display etc).

## ORDERING CODE

N R H 2 4 1 0 T △ 1 0 0 M ○ ○ ○

① Type		② External dimensions (W×L×H)		③ Packaging		④ Nominal inductance (μH)		⑤ Inductance tolerance		⑥ Internal code	
NRH	Coating resin specification	example		T△	Tape & Reel	example		M	±20%	○○○	Standard products
NRS		2410	2.4×2.4×1.0mm	△=Blank Space		2R2	2.2	N	±30%	○	Blank Space
NRV		3010	3.0×3.0×1.0mm			100	10				
		3012	3.0×3.0×1.2mm			101	100				
		5012	5.0×5.0×1.2mm			※R=decimal point					
		5014	5.0×5.0×1.4mm								
		5020	5.0×5.0×2.0mm								
		6010	6.0×6.0×1.0mm								

## EXTERNAL DIMENSIONS/STANDARD QUANTITY

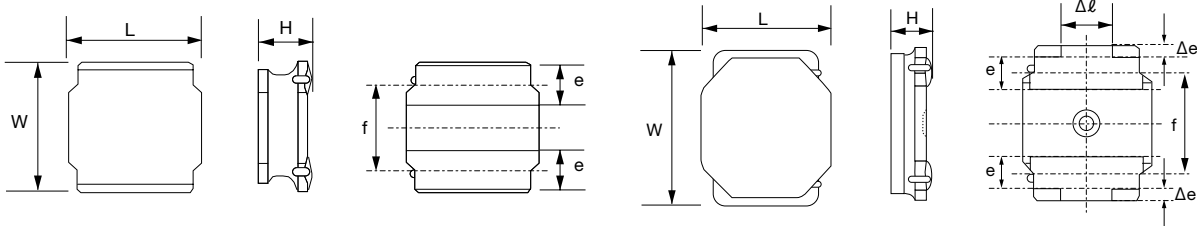

Type	L	W	H	e	f	Standard Quantity [pcs] Tape & Reel
NRH2410	2.4±0.1 (0.095±0.004)	2.4±0.1 (0.095±0.004)	1.0 max (0.039 max)	0.6±0.2 (0.024±0.008)	1.45±0.2 (0.057±0.008)	2500
NRH3010	3.0±0.1 (0.118±0.004)	3.0±0.1 (0.118±0.004)	1.0 max (0.039 max)	0.9±0.2 (0.035±0.008)	1.9±0.2 (0.075±0.008)	2000
NRH3012			1.2 max (0.047 max)			2000
NRV3012						

Unit : mm (inch)

Type	L	W	H	e	Δe	f	Δl	Standard Quantity [pcs] Tape & Reel
NRS5012			1.2 max (0.047 max)					1000
NRS5014	4.9±0.2 (0.193±0.008)	4.9±0.2 (0.193±0.008)	1.4 max (0.055 max)	1.2±0.2 (0.047±0.008)	0.3±0.2 (0.011±0.008)	3.3±0.2 (0.130±0.008)	1.3±0.3 (0.051±0.011)	1000
NRS5020			2.0 max (0.079 max)					800
NRS6010	6.0±0.2 (0.236±0.008)	6.0±0.2 (0.236±0.008)	1.0 max (0.039 max)	1.35±0.2 (0.053±0.008)	0.3±0.2 (0.011±0.008)	4.0±0.2 (0.157±0.008)	2.3±0.3 (0.091±0.011)	1000

Unit : mm (inch)

### Recommended Land Patterns

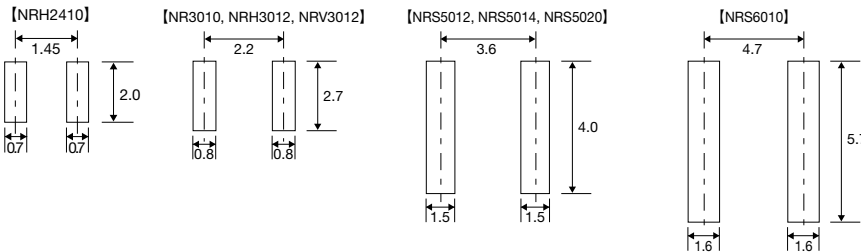

## AVAILABLE INDUCTANCE RANGE

Range	Type	NRH2410		NRH3010		NRH3012		NRV3012		NRS5012		NRS5014		NRS5020		NRS6010	
		I <sub>max</sub> [mA]	R <sub>dc</sub> ±20% [Ω]	I <sub>max</sub> [mA]	R <sub>dc</sub> ±20% [Ω]	I <sub>max</sub> [mA]	R <sub>dc</sub> ±20% [Ω]	I <sub>max</sub> [mA]	R <sub>dc</sub> ±20% [Ω]	I <sub>max</sub> [mA]	R <sub>dc</sub> ±20% [Ω]	I <sub>max</sub> [mA]	R <sub>dc</sub> ±20% [Ω]	I <sub>max</sub> [mA]	R <sub>dc</sub> ±20% [Ω]	I <sub>max</sub> [mA]	R <sub>dc</sub> ±20% [Ω]
1.0	Inductance [μH]	1410	0.070	1480	0.065	1710	0.048			2300	0.053			3600	0.021		
		2.2															
4.7	Inductance [μH]	450	0.690	600	0.350	720	0.270	1100	0.120	850	0.420	1800	0.100	1300	0.120	1000	0.270
		300	1.47	380	0.770												
10	Inductance [μH]					500	0.630							900	0.260		
22																	
100	Inductance [μH]																

\* This catalog contains the typical specification only due to the limitation of space. When you consider purchase of our products, please check our specification. For details of each product (characteristics graph, reliability information, precautions for use, and so on), see our Web site (<http://www.ty-top.com/>) or CD catalogs.

**PART NUMBERS**

●NRH 2410 Shielded type

Ordering code	EHS (Environmental Hazardous Substances)	Inductance [ $\mu$ H]	Inductance Tolerance	Self-resonant frequency [MHz] (min.)	DC Resistance [ $\Omega$ ] ( $\pm 20\%$ )	Rated current ※) [mA]		Measuring frequency [kHz]
						Saturation current Idc1	Temperature rise current Idc2	
NRH2410T R68NN 4	RoHS	0.68	$\pm 30\%$	120	0.060	2,200	1,570	100
NRH2410T 1R0NN 4	RoHS	1.0		106	0.070	1,800	1,410	
NRH2410T 1R5MN	RoHS	1.5	$\pm 20\%$	94	0.110	1,550	1,160	
NRH2410T 2R2MN	RoHS	2.2		77	0.150	1,290	970	
NRH2410T 3R3MN	RoHS	3.3		56	0.220	1,000	770	
NRH2410T 4R7MN	RoHS	4.7		50	0.290	880	670	
NRH2410T 6R8MN	RoHS	6.8		43	0.410	750	570	
NRH2410T 100MN	RoHS	10		32	0.690	550	450	
NRH2410T 150MN	RoHS	15		27	1.02	470	370	
NRH2410T 220MN	RoHS	22		22	1.47	390	300	

●NRH 3010 Type

Ordering code	EHS (Environmental Hazardous Substances)	Inductance [ $\mu$ H]	Inductance Tolerance	Self-resonant frequency [MHz] (min.)	DC Resistance [ $\Omega$ ] ( $\pm 20\%$ )	Rated current ※) [mA]		Measuring frequency [kHz]
						Saturation current Idc1	Temperature rise current Idc2	
NRH3010T 1R2N	RoHS	1.2	$\pm 30\%$	120	0.065	1,700	1,480	100
NRH3010T 1R5N	RoHS	1.5		99	0.075	1,440	1,370	
NRH3010T 2R2M	RoHS	2.2	$\pm 20\%$	86	0.083	1,300	1,300	
NRH3010T 3R3M	RoHS	3.3		64	0.130	1,000	1,030	
NRH3010T 4R7M	RoHS	4.7		50	0.170	850	900	
NRH3010T 6R8M	RoHS	6.8		44	0.250	700	745	
NRH3010T 100M	RoHS	10		34	0.350	600	620	
NRH3010T 150M	RoHS	15		25	0.550	450	480	
NRH3010T 220M	RoHS	22		22	0.770	380	410	

●NRH 3012 Type

Ordering code	EHS (Environmental Hazardous Substances)	Inductance [ $\mu$ H]	Inductance Tolerance	Self-resonant frequency [MHz] (min.)	DC Resistance [ $\Omega$ ] ( $\pm 20\%$ )	Rated current ※) [mA]		Measuring frequency [kHz]
						Saturation current Idc1	Temperature rise current Idc2	
NRH3012T 1R0N	RoHS	1.0	$\pm 30\%$	111	0.048	2,200	1,710	100
NRH3012T 1R5N	RoHS	1.5		95	0.055	1,700	1,600	
NRH3012T 2R2M	RoHS	2.2	$\pm 20\%$	78	0.075	1,500	1,370	
NRH3012T 3R3M	RoHS	3.3		61	0.100	1,200	1,210	
NRH3012T 4R7M	RoHS	4.7		50	0.130	1,000	1,060	
NRH3012T 6R8M	RoHS	6.8		43	0.190	850	890	
NRH3012T 100M	RoHS	10		32	0.270	730	720	
NRH3012T 150M	RoHS	15		26	0.450	530	570	
NRH3012T 220M	RoHS	22		22	0.630	500	500	

●NRV 3012 Type

Ordering code	EHS (Environmental Hazardous Substances)	Inductance [ $\mu$ H]	Inductance Tolerance	Self-resonant frequency [MHz] (min.)	DC Resistance [ $\Omega$ ] ( $\pm 20\%$ )	Rated current ※) [mA]		Measuring frequency [kHz]
						Saturation current Idc1	Temperature rise current Idc2	
NRV3012T 2R2M	RoHS	2.2	$\pm 20\%$	70	0.120	1,800	1,100	100

●NRS 5012 Type

Ordering code	EHS (Environmental Hazardous Substances)	Inductance [ $\mu$ H]	Inductance Tolerance	Self-resonant frequency [MHz] (min.)	DC Resistance [ $\Omega$ ] ( $\pm 20\%$ )	Rated current ※) [mA]		Measuring frequency [kHz]
						Saturation current Idc1	Temperature rise current Idc2	
NRS5012T 1R0N	RoHS	1.0	$\pm 30\%$	100	0.053	4,500	2,300	100
NRS5012T 1R5N	RoHS	1.5		86	0.070	3,800	2,200	
NRS5012T 2R2M	RoHS	2.2	$\pm 20\%$	70	0.085	3,100	2,000	
NRS5012T 3R3M	RoHS	3.3		48	0.160	2,400	1,450	
NRS5012T 4R7M	RoHS	4.7		40	0.180	2,200	1,400	
NRS5012T 6R8M	RoHS	6.8		36	0.260	1,700	1,100	
NRS5012T 100M	RoHS	10		26	0.420	1,400	850	

●NRS 5014 Type

Ordering code	EHS (Environmental Hazardous Substances)	Inductance [ $\mu$ H]	Inductance Tolerance	Self-resonant frequency [MHz] (min.)	DC Resistance [ $\Omega$ ] ( $\pm 20\%$ )	Rated current ※) [mA]		Measuring frequency [kHz]
						Saturation current Idc1	Temperature rise current Idc2	
NRS5014T 1R2N	RoHS	1.2	$\pm 30\%$	86	0.045	3,800	2,800	100
NRS5014T 2R2N	RoHS	2.2		56	0.065	2,800	2,300	
NRS5014T 3R3N	RoHS	3.3		48	0.080	2,350	2,100	
NRS5014T 4R7N	RoHS	4.7		41	0.100	2,050	1,800	

\* This catalog contains the typical specification only due to the limitation of space. When you consider purchase of our products, please check our specification. For details of each product (characteristics graph, reliability information, precautions for use, and so on), see our Web site (<http://www.ty-top.com/>) or CD catalogs.

■ PART NUMBERS

● NRS 5020 Type

Ordering code	EHS (Environmental Hazardous Substances)	Inductance [ $\mu$ H]	Inductance Tolerance	Self-resonant frequency [MHz] (min.)	DC Resistance [ $\Omega$ ] ( $\pm 20\%$ )	Rated current ※) [mA]		Measuring frequency [kHz]
						Saturation current Idc1	Temperature rise current Idc2	
NRS5020T 1R0N	RoHS	1.0	$\pm 30\%$	81	0.021	4,000	3,600	100
NRS5020T 1R5N	RoHS	1.5		68	0.026	3,350	3,200	
NRS5020T 2R2N	RoHS	2.2		57	0.035	2,900	2,900	
NRS5020T 3R3N	RoHS	3.3	$\pm 20\%$	46	0.048	2,400	2,400	
NRS5020T 4R7M	RoHS	4.7		37	0.060	2,000	2,000	
NRS5020T 6R8M	RoHS	6.8		30	0.090	1,600	1,650	
NRS5020T 100M	RoHS	10		24	0.120	1,300	1,450	
NRS5020T 150M	RoHS	15		20	0.165	1,100	1,200	
NRS5020T 220M	RoHS	22		17	0.260	900	1,000	

● NRS 6010 Type

Ordering code	EHS (Environmental Hazardous Substances)	Inductance [ $\mu$ H]	Inductance Tolerance	Self-resonant frequency [MHz] (min.)	DC Resistance [ $\Omega$ ] ( $\pm 20\%$ )	Rated current ※) [mA]		Measuring frequency [kHz]
						Saturation current Idc1	Temperature rise current Idc2	
NRS6010T 1R5N	RoHS	1.5	$\pm 30\%$	90	0.090	2,400	1,900	100
NRS6010T 2R2N	RoHS	2.2		65	0.110	1,900	1,700	
NRS6010T 3R3N	RoHS	3.3		50	0.135	1,600	1,500	
NRS6010T 4R7N	RoHS	4.7		38	0.165	1,300	1,400	
NRS6010T 6R8N	RoHS	6.8		30	0.220	1,200	1,200	
NRS6010T 100M	RoHS	10	$\pm 20\%$	25	0.270	1,000	1,100	

※) The saturation current value (Idc1) is the DC current value having inductance decrease down to 30%. (at 20°C)

※) The temperature rise current value (Idc2) is the DC current value having temperature increase up to 40°C. (at 20°C)

※) The rated current is the DC current value that satisfies both of current value saturation current value and temperature rise current value.

DC Bias characteristics

(Measured by HP4285A)

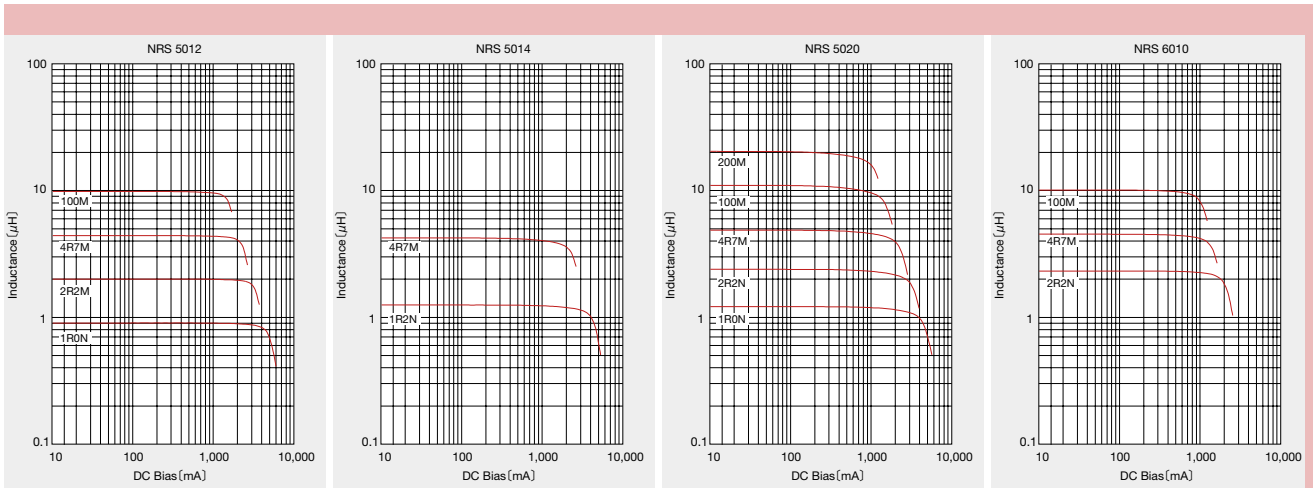
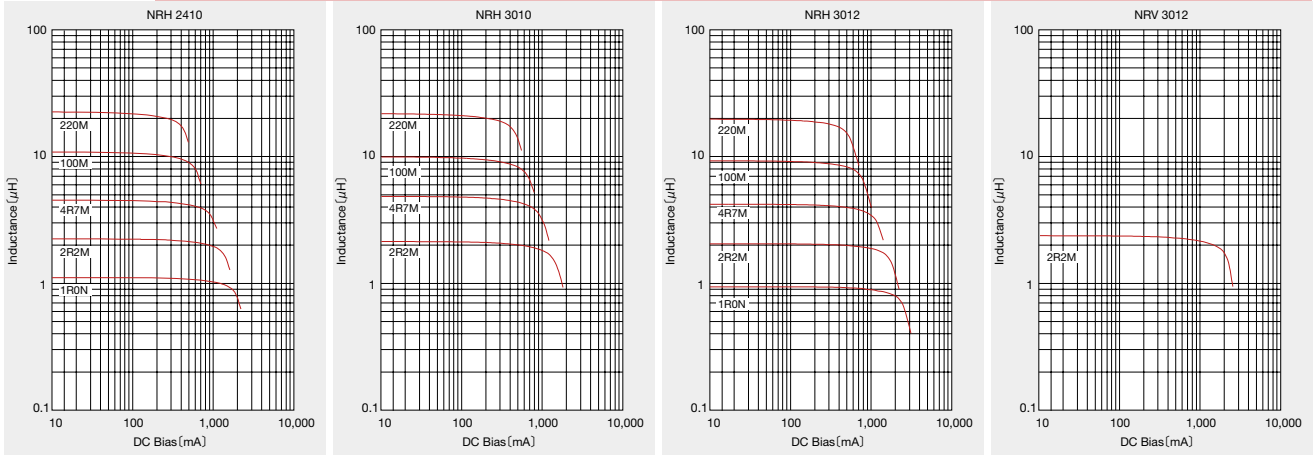

\* This catalog contains the typical specification only due to the limitation of space. When you consider purchase of our products, please check our specification. For details of each product (characteristics graph, reliability information, precautions for use, and so on), see our Web site (<http://www.ty-top.com/>) or CD catalogs.



# PACKAGING

## ① Minimum Quantity

Type	Standard Quantity [pcs]
	Tape & Reel
NRH 2410	2500
NR 3010/NRH 3010	2000
NR 3012/NRH3012/NRV3012	2000
NR 3015	2000
NR 4010	5000
NR 4012	4500
NR 4018	3500
NRG4026	2000
NRS5012	1000
NRS5014	1000
NRS5020	800
NR 5040	1500
NRS6010	1000
NR 6012	1000
NR 6020	2500
NR 6028	2000
NR 6045	1500
NR 8040	1000

## ② Tape Material

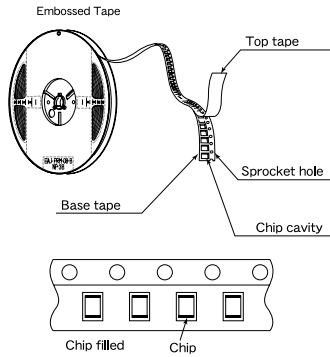

## ③ Taping dimensions

- Embossed tape 8mm wide (0.315 inches wide)

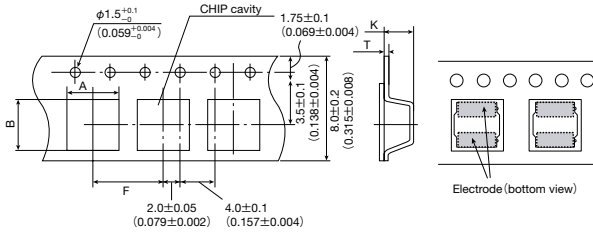

Type	Chip cavity		Insertion pitch F	Tape thickness	
	A	B		T	K
NRH 2410	2.6 $\pm$ 0.1 (0.102 $\pm$ 0.004)	2.6 $\pm$ 0.1 (0.102 $\pm$ 0.004)	4.0 $\pm$ 0.1 (0.157 $\pm$ 0.004)	0.25 $\pm$ 0.05 (0.009 $\pm$ 0.002)	1.3 $\pm$ 0.1 (0.051 $\pm$ 0.004)
NR 3010 NRH 3010	3.2 $\pm$ 0.1 (0.126 $\pm$ 0.004)	3.2 $\pm$ 0.1 (0.126 $\pm$ 0.004)		0.3 $\pm$ 0.05 (0.012 $\pm$ 0.002)	1.4 $\pm$ 0.1 (0.055 $\pm$ 0.004)
NR 3012 NRH 3012 NRV3012			1.6 $\pm$ 0.1 (0.063 $\pm$ 0.004)		
NR 3015			1.9 $\pm$ 0.1 (0.075 $\pm$ 0.004)		

Unit : mm (inch)

- Embossed tape 12mm wide (0.47 inches wide)

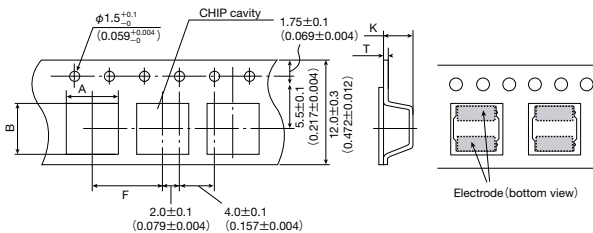

Type	Chip cavity		Insertion pitch F	Tape thickness	
	A	B		T	K
NR 4010	4.3 $\pm$ 0.1 (0.169 $\pm$ 0.004)	4.3 $\pm$ 0.1 (0.169 $\pm$ 0.004)	8.0 $\pm$ 0.1 (0.315 $\pm$ 0.004)	0.3 $\pm$ 0.05 (0.012 $\pm$ 0.002)	1.4 $\pm$ 0.1 (0.055 $\pm$ 0.004)
NR 4012				1.6 $\pm$ 0.1 (0.063 $\pm$ 0.004)	
NR 4018				2.1 $\pm$ 0.1 (0.083 $\pm$ 0.004)	
NRG 4026				3.1 $\pm$ 0.1 (0.122 $\pm$ 0.004)	
NRS 5012	5.25 $\pm$ 0.1 (0.207 $\pm$ 0.004)	5.25 $\pm$ 0.1 (0.207 $\pm$ 0.004)	8.0 $\pm$ 0.1 (0.315 $\pm$ 0.004)	0.3 $\pm$ 0.05 (0.012 $\pm$ 0.002)	1.4 $\pm$ 0.1 (0.055 $\pm$ 0.004)
NRS 5014					1.6 $\pm$ 0.1 (0.063 $\pm$ 0.004)
NRS 5020	5.15 $\pm$ 0.1 (0.203 $\pm$ 0.004)	5.15 $\pm$ 0.1 (0.203 $\pm$ 0.004)	8.0 $\pm$ 0.1 (0.315 $\pm$ 0.004)	0.3 $\pm$ 0.05 (0.012 $\pm$ 0.002)	2.3 $\pm$ 0.1 (0.091 $\pm$ 0.004)
NR 5040					4.2 $\pm$ 0.1 (0.165 $\pm$ 0.004)
NRS 6010	6.3 $\pm$ 0.1 (0.248 $\pm$ 0.004)	6.3 $\pm$ 0.1 (0.248 $\pm$ 0.004)	8.0 $\pm$ 0.1 (0.315 $\pm$ 0.004)	0.4 $\pm$ 0.1 (0.016 $\pm$ 0.004)	1.4 $\pm$ 0.1 (0.055 $\pm$ 0.004)
NR 6012					1.6 $\pm$ 0.1 (0.063 $\pm$ 0.004)
NR 6020					2.3 $\pm$ 0.1 (0.090 $\pm$ 0.004)
NR 6028					3.1 $\pm$ 0.1 (0.122 $\pm$ 0.004)
NR 6045	6.3 $\pm$ 0.1 (0.248 $\pm$ 0.004)	6.3 $\pm$ 0.1 (0.248 $\pm$ 0.004)	8.0 $\pm$ 0.1 (0.315 $\pm$ 0.004)	0.4 $\pm$ 0.1 (0.016 $\pm$ 0.004)	4.7 $\pm$ 0.1 (0.185 $\pm$ 0.004)
NR 8040					4.5 $\pm$ 0.1 (0.177 $\pm$ 0.004)

Unit : mm (inch)

- Embossed tape 16mm wide (0.63 inches wide)

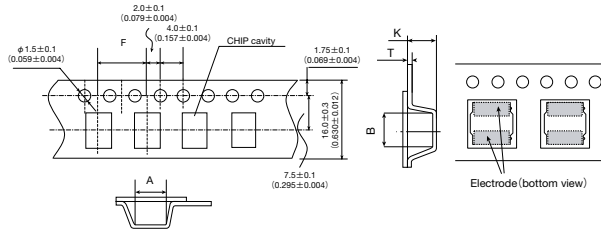

Type	Chip cavity		Insertion pitch F	Tape thickness	
	A	B		T	K
NR 8040	8.3 $\pm$ 0.1 (0.327 $\pm$ 0.004)	8.3 $\pm$ 0.1 (0.327 $\pm$ 0.004)	12.0 $\pm$ 0.1 (0.472 $\pm$ 0.004)	0.5 $\pm$ 0.1 (0.020 $\pm$ 0.004)	4.5 $\pm$ 0.1 (0.177 $\pm$ 0.004)

Unit : mm (inch)

## ④ Leader and Blank portion

- NR, NRH, NRS, NRG, NRV

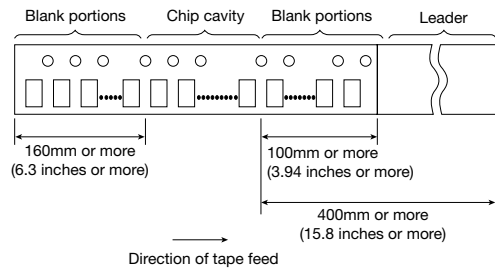

\* This catalog contains the typical specification only due to the limitation of space. When you consider purchase of our products, please check our specification. For details of each product (characteristics graph, reliability information, precautions for use, and so on), see our Web site (<http://www.ty-top.com/>) or CD catalogs.

⑤ Reel size

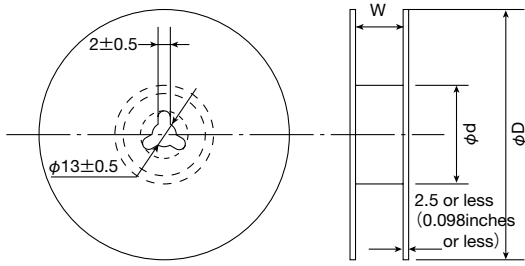

Type	Reel size (Reference values)		
	φD	φd	W
NRH2410	180±0.5 (7.087±0.019)	60±1.0 (2.36±0.04)	10.0±1.5 (0.394±0.059)
NR 3010			
NRH 3010			
NR 3012			
NRV 3012			
NR 3015	180±3.0 (7.087±0.118)	60±2.0 (2.36±0.08)	14.0±1.5 (0.551±0.059)
NRS 5012			
NRS 5014			
NRS 5020			
NRS 6010			
NR 6012			

Unit : mm (inch)

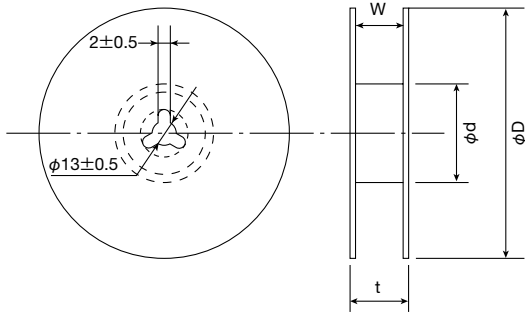

Type	Reel size (Reference values)			
	φD	φd	t (max.)	W
NR 4010	330±3.0 (12.99±0.118)	80±2.0 (3.15±0.078)	18.5 (0.72)	13.5±1.0 (0.531±0.04)
NR 4012				
NR 4018				
NRG 4026				
NR 5040				
NR 6020				
NR 6028				
NR 6045				
NR 8040	22.5 (0.89)	17.5±1.0 (0.689±0.04)		

Unit : mm (inch)

⑥ Top Tape Strength

The top tape requires a peel-off force of 0.1 to 1.3N in the direction of the arrow as illustrated below.

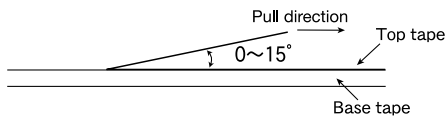

\* This catalog contains the typical specification only due to the limitation of space. When you consider purchase of our products, please check our specification. For details of each product (characteristics graph, reliability information, precautions for use, and so on), see our Web site (<http://www.ty-top.com/>) or CD catalogs.

# SMD INDUCTORS LARGE CURRENT TYPE



## FEATURES

- SMD inductor.
- It corresponds to High current.
- Simple and original magnetic shield structure.

## APPLICATIONS

- Power supply circuits / DC-DC converters in a variety of applications such as PDP TV, LCD TV, HDD, PC, etc.

## ORDERING CODE

N R  $\triangle$  1 0 0 5 0 T  $\triangle$  1 0 0 M  $\triangle$

<b>1</b> Type	<b>2</b> External dimensions (W×H)	<b>3</b> Packaging	<b>4</b> Nominal inductance ( $\mu$ H)	<b>5</b> Inductance tolerance	<b>6</b> Internal code
NR $\triangle$ Coating resin specification $\triangle$ =Blank Space	example 10050 10.0×5.0mm	T $\triangle$ Tape & Reel $\triangle$ =Blank Space	example 1R3 1.3 100 10 101 100 ※R=decimal point	M $\pm$ 20% N $\pm$ 30%	$\triangle$ Standard product $\triangle$ =Blank Space

## EXTERNAL DIMENSIONS/STANDARD QUANTITY

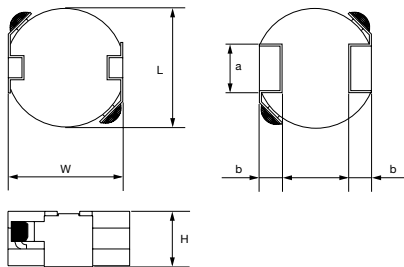

**Recommended Land Patterns**  
Surface Mounting  
 • Mounting and soldering conditions should be checked beforehand.  
 • Applicable soldering process to these products is reflow soldering only.

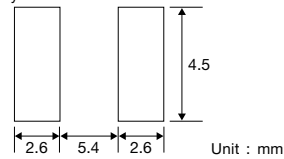

Type	L	W	H	a	b	Standard Quantity [pcs] Tape & Reel
NR 10050	10.0±0.3 (0.394±0.012)	9.8±0.5 (0.386±0.020)	5.0 max (0.197 max)	4.0 (0.16)	1.75 (0.07)	500

Unit : mm (inch)

## AVAILABLE INDUCTANCE RANGE

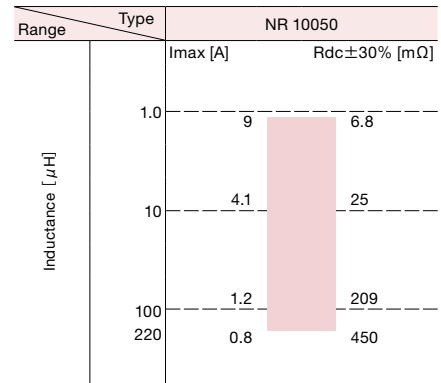

## PART NUMBERS

### NR 10050 type

Ordering code	EHS (Environmental Hazardous Substances)	Inductance [ $\mu$ H]	Inductance Tolerance	Self-resonant frequency [MHz] (min.)	DC Resistance [ $\Omega$ ] ( $\pm$ 30%)	Rated current ※) [mA]		Measuring frequency [kHz]
						Saturation current Idc1	Temperature rise current Idc2	
NR10050T1R3N	RoHS	1.3	$\pm$ 30%	53	0.0068	11000	9000	100
NR10050T2R1N	RoHS	2.1		37	0.008	10000	8300	
NR10050T2R9N	RoHS	2.9		29	0.0093	8200	7300	
NR10050T3R8N	RoHS	3.8		26	0.013	7300	6800	
NR10050T4R9N	RoHS	4.9		23	0.015	6600	6000	
NR10050T6R5N	RoHS	6.5		19	0.018	6000	5200	
NR10050T100M	RoHS	10	$\pm$ 20%	15	0.025	4700	4100	
NR10050T150M	RoHS	15		11	0.035	3600	3200	
NR10050T220M	RoHS	22		10	0.045	2600	2500	
NR10050T330M	RoHS	33		8.2	0.066	2500	2100	
NR10050T470M	RoHS	47		7.0	0.092	2000	1800	
NR10050T680M	RoHS	68		5.6	0.144	1700	1500	
NR10050T101M	RoHS	100		4.6	0.209	1300	1200	
NR10050T221M	RoHS	220		3.0	0.450	1000	800	

※) The saturation current value (Idc1) is the DC current value having inductance decrease down to 30%. (at 20°C)

※) The temperature rise current value (Idc2) is the DC current value having temperature increase up to 40°C. (at 20°C)

※) The maximum rated current is the DC current value that satisfies both of current value Saturation current value and temperature rise current value. (at 20°C)

\* This catalog contains the typical specification only due to the limitation of space. When you consider purchase of our products, please check our specification. For details of each product (characteristics graph, reliability information, precautions for use, and so on), see our Web site (<http://www.ty-top.com/>) or CD catalogs.

DC Bias characteristics (Measured by HP4285A)

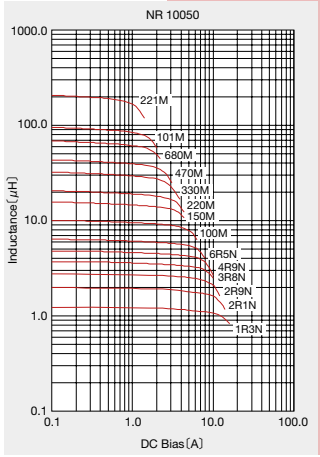

\* This catalog contains the typical specification only due to the limitation of space. When you consider purchase of our products, please check our specification. For details of each product (characteristics graph, reliability information, precautions for use, and so on), see our Web site (<http://www.ty-top.com/>) or CD catalogs.

## PACKAGING

### ① Minimum Quantity

Type	Standard Quantity [pcs]
	Tape & Reel
NR 10050	500

### ② Tape Material

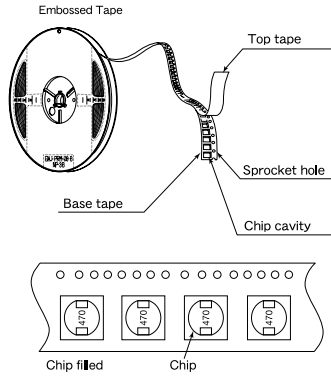

### ③ Taping dimensions

- Embossed tape 24mm wide (0.945 inches wide)

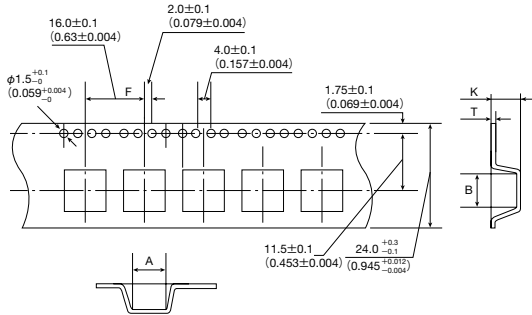

Type	Chip cavity		Insertion pitch	Tape thickness	
	A	B	F	T	K
NR 10050	10.4±0.1 (0.409±0.004)	9.9±0.1 (0.390±0.004)	16.0±0.1 (0.630±0.004)	0.5±0.05 (0.020±0.002)	5.7±0.1 (0.224±0.004)

Unit : mm (inch)

### ④ Leader and Blank portion

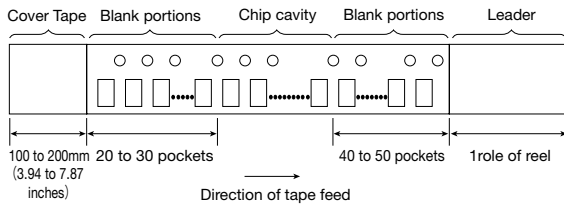

### ⑤ Reel size

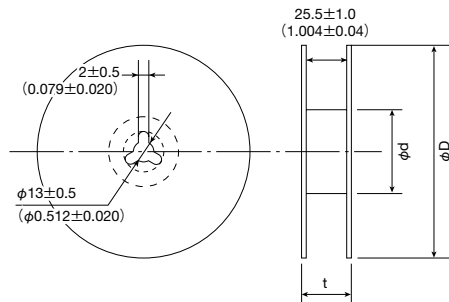

Type	Reel size (Reference values)		
	φD	φd	t (max.)
NR 10050	330±3 (12.99±0.118)	80±2 (3.15±0.078)	30.5 (1.201)

Unit : mm (inch)

### ⑥ Top Tape Strength

The top tape requires a peel-off force of 0.1 to 0.7N in the direction of the arrow as illustrated below.

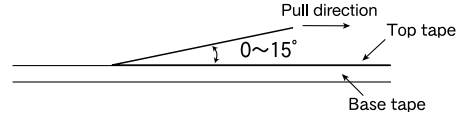

\* This catalog contains the typical specification only due to the limitation of space. When you consider purchase of our products, please check our specification. For details of each product (characteristics graph, reliability information, precautions for use, and so on), see our Web site (<http://www.ty-top.com/>) or CD catalogs.

# SMD INDUCTORS COMPACT TYPE



REFLOW

## FEATURES

- BR C2518/BRFL2518 (NEW PRODUCTS)  
The best efficiency design is achieved by adopting bottom-surface electrode structure. Small and low-profile Wound Chip Inductors that are suitable for module design which needs high electric current like DC/DC converters.

## APPLICATIONS

- For small DC/DC converter (cellular phone, HDD, DVC, DSC, PDA, LCD display etc).

## ORDERING CODE

**B** **R** **△** **2** **5** **1** **8** **T** **2** **R** **2** **M** **△** **△** **△**

<b>1</b> Type	<b>2</b> Characteristic Spec	<b>3</b> External Dimensions (W×L) : mm (inch)	<b>4</b> Packaging	<b>5</b> Nominal Inductance [μH]	<b>6</b> Inductance tolerance	<b>7</b> Internal code
BR SMD Inductors	△ Low Rdc L Low profile C High Current FL Low profile	1608 (0603) 1.6×0.8mm 2012 (0805) 2.0×1.2mm 2016 (0806) 2.0×1.6mm 2518 (1007) 2.5×1.8mm 3225 (1210) 3.2×2.5mm	T Tape & Reel	example R20 0.2 1R0 1.0 2R2 2.2 4R7 4.7	M ±20% K ±10%	△△△ Standard product △=Blank Space

\*R=decimal point

## EXTERNAL DIMENSIONS/STANDARD QUANTITY

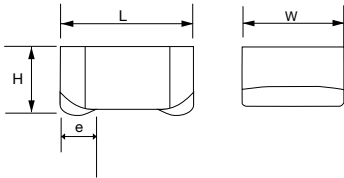

Type	L	W	H	e	Standard Quantity [pcs]	
					Paper Tape	Embossed Tape
BR C1608	1.6±0.2 (0.063±0.008)	0.8±0.2 (0.031±0.008)	0.8±0.2 (0.031±0.008)	0.45±0.15 (0.016±0.006)	—	3000
BR L2012	2.0±0.2 (0.078±0.008)	1.25±0.2 (0.049±0.008)	1.0 max. (0.040 max.)	0.5±0.2 (0.020±0.008)	—	3000
BR C2016	2.0±0.2 (0.078±0.008)	1.6±0.2 (0.063±0.008)	1.6±0.2 (0.063±0.008)	0.5±0.2 (0.020±0.008)	—	2000
BR C2518	2.5±0.2 (0.098±0.008)	1.8±0.2 (0.071±0.008)	1.8±0.2 (0.071±0.008)	0.5±0.2 (0.020±0.008)	—	2000
BR L2518	2.5±0.2 (0.098±0.008)	1.8±0.2 (0.071±0.008)	1.2 max. (0.048 max.)	0.5±0.2 (0.020±0.008)	—	3000
BRFL2518	2.5±0.2 (0.098±0.008)	1.8±0.2 (0.071±0.008)	1.0 max. (0.040 max.)	0.5±0.2 (0.020±0.008)	—	3000
BR L3225	3.2±0.2 (0.126±0.008)	2.5±0.2 (0.098±0.008)	1.7 max. (0.068 max.)	0.75±0.2 (0.030±0.008)	—	2000

Unit : mm (inch)

Recommended Land Patterns  
Surface Mounting  
• Mounting and soldering conditions should be checked beforehand.  
• Applicable soldering process to this products is reflow soldering only.

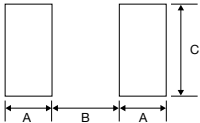

Type	A	B	C
1608	0.55	0.80	0.90
2012	0.65	0.90	1.40
2016	0.70	0.80	1.80
2518	0.65	1.50	1.95
3225	1.00	1.60	2.70

Unit : mm

## AVAILABLE INDUCTANCE RANGE

Range	Type	BR L3225		BRFL2518		BR L2518		BR C2518		BR C2016		BR L2012		BR C1608													
		I <sub>max</sub> [mA]	R <sub>dc</sub> ±30% [Ω]	I <sub>max</sub> [mA]	R <sub>dc</sub> ±30% [Ω]	I <sub>max</sub> [mA]	R <sub>dc</sub> ±30% [Ω]	I <sub>max</sub> [mA]	R <sub>dc</sub> ±30% [Ω]	I <sub>max</sub> [mA]	R <sub>dc</sub> ±30% [Ω]	I <sub>max</sub> [mA]	R <sub>dc</sub> ±30% [Ω]	I <sub>max</sub> [mA]	R <sub>dc</sub> ±30% [Ω]												
Inductance [μH]	1.0	2,200	1μH	0.043	1,200	1μH	0.080	1,000	1μH	0.080	1,650	1μH	0.050	1,100	1μH	0.085	850	1,050	0.47μH	0.090	980	0.2μH	0.060	520	0.180		
	2.2				850		0.135	850		0.135														280	0.550		
	4.7				650	4.7μH	0.330	470	4.7μH	0.400																	
	10										610		0.350	520		0.400	270										
	22																										
47																											
100																											
220																											

\* This catalog contains the typical specification only due to the limitation of space. When you consider purchase of our products, please check our specification. For details of each product (characteristics graph, reliability information, precautions for use, and so on), see our Web site (<http://www.ty-top.com/>) or CD catalogs.

**PART NUMBERS**

● BR C1608 type

Ordering code	EHS (Environmental Hazardous Substances)	Inductance [ $\mu$ H]	Inductance Tolerance	Self-resonant frequency [MHz] (min.)	DC Resistance [ $\Omega$ ] ( $\pm$ 30%)	Rated current ※) [mA]		Measuring frequency [MHz]
						Saturation current Idc1	Temperature rise current Idc2	
BR C1608TR20M	RoHS	0.20	$\pm$ 20%	400	0.060	1,750	980	7.96
BR C1608TR35M	RoHS	0.35		300	0.080	1,400	810	
BR C1608TR45M	RoHS	0.45		200	0.090	1,250	800	
BR C1608TR56M	RoHS	0.56		170	0.095	1,150	760	
BR C1608TR77M	RoHS	0.77		150	0.110	1,000	660	
BR C1608T1R0M	RoHS	1.00		140	0.180	850	520	
BR C1608T1R5M	RoHS	1.50		120	0.300	700	410	
BR C1608T2R2M	RoHS	2.20		100	0.550	550	280	

● BR L2012 type

Ordering code	EHS (Environmental Hazardous Substances)	Inductance [ $\mu$ H]	Inductance Tolerance	Self-resonant frequency [MHz] (min.)	DC Resistance [ $\Omega$ ] ( $\pm$ 30%)	Rated current ※) [mA]		Measuring frequency [MHz]
						Saturation current Idc1	Temperature rise current Idc2	
BR L2012TR47M	RoHS	0.47	$\pm$ 20%	350	0.090	1,100	1,050	7.96
BR L2012T1R0M	RoHS	1.0		300	0.135	850	850	
BR L2012T1R5M	RoHS	1.5		250	0.180	700	750	
BR L2012T2R2M	RoHS	2.2		200	0.300	600	550	
BR L2012T3R3M	RoHS	3.3		190	0.500	490	440	
BR L2012T4R7M	RoHS	4.7		150	0.550	340	400	
BR L2012T6R8M	RoHS	6.8		60	0.750	290	350	
BR L2012T100M	RoHS	10		30	0.850	270	330	
BR L2012T150M	RoHS	15		15	1.00	220	300	
BR L2012T220M	RoHS	22		13	1.30	190	270	
BR L2012T330M	RoHS	33	8.0	2.00	150	220	2.52	
BR L2012T470M	RoHS	47	7.0	3.50	125	160		
BR L2012T680M	RoHS	68	6.5	5.80	100	110		
BR L2012T101M	RoHS	100	6.0	7.70	85	85		0.796

● BR C2016 type

Ordering code	EHS (Environmental Hazardous Substances)	Inductance [ $\mu$ H]	Inductance Tolerance	Self-resonant frequency [MHz] (min.)	DC Resistance [ $\Omega$ ] ( $\pm$ 30%)	Rated current ※) [mA]		Measuring frequency [MHz]
						Saturation current Idc1	Temperature rise current Idc2	
BR C2016T1R0M	RoHS	1.0	$\pm$ 20%	450	0.085	1,350	1,100	0.10
BR C2016T1R5M	RoHS	1.5		370	0.150	1,100	820	
BR C2016T2R2M	RoHS	2.2		250	0.180	910	760	
BR C2016T3R3M	RoHS	3.3		140	0.220	740	680	
BR C2016T4R7M	RoHS	4.7		78	0.270	660	610	
BR C2016T6R8M	RoHS	6.8		39	0.330	550	560	
BR C2016T100□	RoHS	10	$\pm$ 20% $\pm$ 10%	35	0.400	450	520	
BR C2016T150□	RoHS	15		28	0.600	400	410	
BR C2016T220□	RoHS	22		24	1.00	310	310	
BR C2016T330□	RoHS	33		13	1.70	270	240	
BR C2016T470□	RoHS	47		11	2.20	210	210	
BR C2016T680□	RoHS	68		8	2.80	200	190	
BR C2016T101□	RoHS	100	7	3.40	140	170		

● BR C2518 type

Ordering code	EHS (Environmental Hazardous Substances)	Inductance [ $\mu$ H]	Inductance Tolerance	Self-resonant frequency [MHz] (min.)	DC Resistance [ $\Omega$ ] ( $\pm$ 30%)	Rated current ※) [mA]		Measuring frequency [MHz]
						Saturation current Idc1	Temperature rise current Idc2	
BR C2518T1R0M	RoHS	1.0	$\pm$ 20%	280	0.050	2,550	1,650	1.00
BR C2518T1R5M	RoHS	1.5		230	0.080	2,100	1,300	
BR C2518T2R2M	RoHS	2.2		200	0.120	1,800	1,000	
BR C2518T3R3M	RoHS	3.3		150	0.175	1,450	860	
BR C2518T4R7M	RoHS	4.7		100	0.230	1,250	750	
BR C2518T6R8M	RoHS	6.8		45	0.280	1,050	680	
BR C2518T100□	RoHS	10	$\pm$ 20% $\pm$ 10%	20	0.350	890	610	
BR C2518T150□	RoHS	15		13	0.43	760	550	
BR C2518T220□	RoHS	22		10	0.56	640	490	
BR C2518T330□	RoHS	33		8	0.85	560	390	
BR C2518T470□	RoHS	47		6.5	1.45	410	300	
BR C2518T680□	RoHS	68		5.5	2.40	340	230	
BR C2518T101□	RoHS	100	4.5	3.60	300	190		

• Please specify the inductance tolerance code. (M or K)

※) The saturation current value (Idc1) is the DC current value having inductance decrease down to 30%. (at 20°C)

※) The temperature rise current value (Idc2) is the DC current value having temperature increase up to 40°C. (at 20°C)

※) The rated current is the DC current value that satisfies both of DC saturation current value and temperature rise current value.

\* This catalog contains the typical specification only due to the limitation of space. When you consider purchase of our products, please check our specification. For details of each product (characteristics graph, reliability information, precautions for use, and so on), see our Web site (<http://www.ty-top.com/>) or CD catalogs.

## PART NUMBERS

### BR L2518 type

Ordering code	EHS (Environmental Hazardous Substances)	Inductance [ $\mu$ H]	Inductance Tolerance	Self-resonant frequency [MHz] (min.)	DC Resistance [ $\Omega$ ] ( $\pm$ 30%)	Rated current ※) [mA]		Measuring frequency [MHz]
						Saturation current Idc1	Temperature rise current Idc2	
BR L2518T1R0M	RoHS	1.0	$\pm$ 20%	130	0.080	1,300	1,000	7.96
BR L2518T1R5M	RoHS	1.5		100	0.100	1,200	920	
BR L2518T2R2M	RoHS	2.2		80	0.135	900	850	
BR L2518T3R3M	RoHS	3.3		70	0.300	750	580	
BR L2518T4R7M	RoHS	4.7		60	0.400	650	470	

### BRFL2518 type

Ordering code	EHS (Environmental Hazardous Substances)	Inductance [ $\mu$ H]	Inductance Tolerance	Self-resonant frequency [MHz] (min.)	DC Resistance [ $\Omega$ ] ( $\pm$ 30%)	Rated current ※) [mA]		Measuring frequency [MHz]
						Saturation current Idc1	Temperature rise current Idc2	
BRFL2518T1R0M	RoHS	1.0	$\pm$ 20%	130	0.090	1,200	1,200	1.00
BRFL2518T1R5M	RoHS	1.5		100	0.110	1100	1000	
BRFL2518T2R2M	RoHS	2.2		80	0.130	850	950	
BRFL2518T3R3M	RoHS	3.3		70	0.220	700	700	
BRFL2518T4R7M	RoHS	4.7		60	0.330	650	650	

### BR L3225 type

Ordering code	EHS (Environmental Hazardous Substances)	Inductance [ $\mu$ H]	Inductance Tolerance	Self-resonant frequency [MHz] (min.)	DC Resistance [ $\Omega$ ] ( $\pm$ 30%)	Rated current ※) [mA]		Measuring frequency [MHz]
						Saturation current Idc1	Temperature rise current Idc2	
BR L3225T1R0M	RoHS	1.0	$\pm$ 20%	220	0.043	2,400	2,200	0.10
BR L3225T1R5M	RoHS	1.5		170	0.045	2,200	1,750	
BR L3225T2R2M	RoHS	2.2		150	0.065	1,850	1,600	
BR L3225T3R3M	RoHS	3.3		140	0.120	1,450	1,200	
BR L3225T4R7M	RoHS	4.7		120	0.180	1,300	1,000	
BR L3225T6R8M	RoHS	6.8	90	0.270	1,050	770		
BR L3225T100□	RoHS	10	$\pm$ 20% $\pm$ 10%	70	0.350	900	700	
BR L3225T150□	RoHS	15		20	0.570	700	530	
BR L3225T220□	RoHS	22		13	0.690	550	470	
BR L3225T330□	RoHS	33		9	0.840	470	420	
BR L3225T470□	RoHS	47		7	1.00	420	390	
BR L3225T680□	RoHS	68		6	1.40	330	300	
BR L3225T101□	RoHS	100		5	2.50	270	250	

\* Please specify the inductance tolerance code. (M or K)

※) The saturation current value (Idc1) is the DC current value having inductance decrease down to 30%. (at 20°C)

※) The temperature rise current value (Idc2) is the DC current value having temperature increase up to 40°C. (at 20°C)

※) The rated current is the DC current value that satisfies both of DC saturation current value and temperature rise current value.



DC Bias characteristics

(Measured by HP4285A)

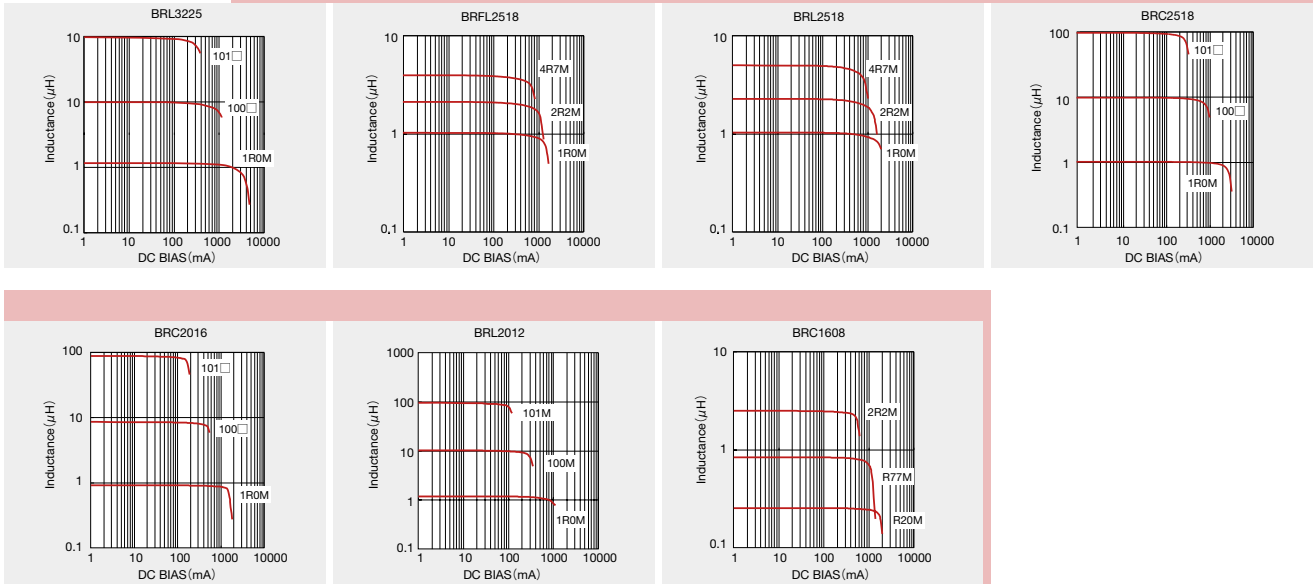

Impedance-vs-Frequency characteristics

(Measured by HP4291A)

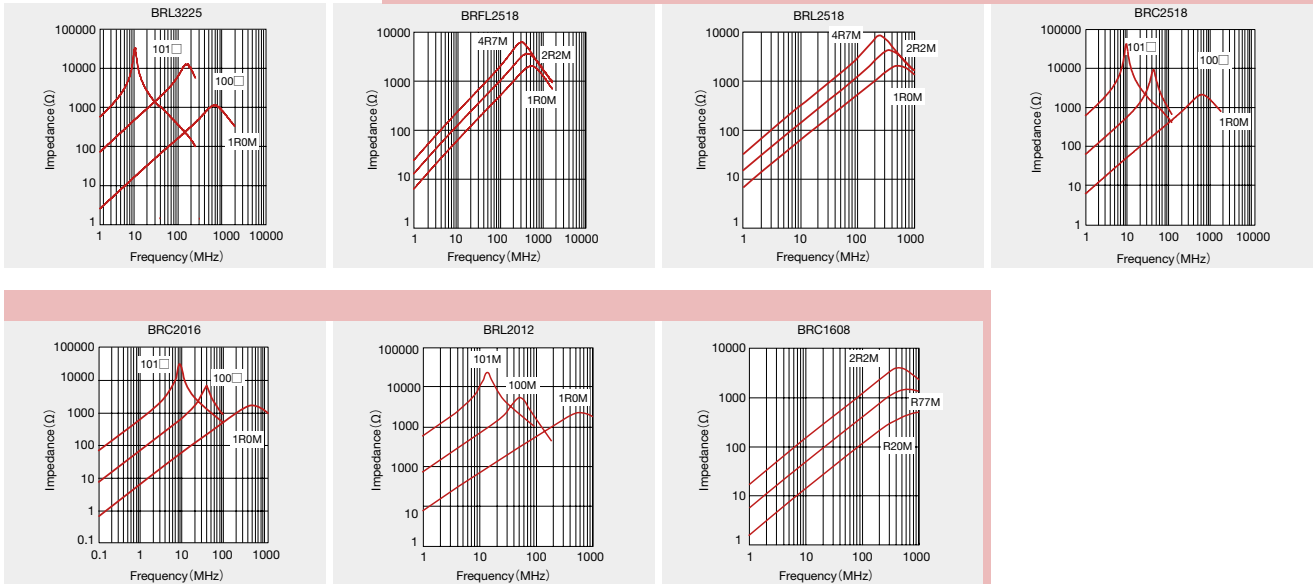

\* This catalog contains the typical specification only due to the limitation of space. When you consider purchase of our products, please check our specification. For details of each product (characteristics graph, reliability information, precautions for use, and so on), see our Web site (<http://www.ty-top.com/>) or CD catalogs.

① Minimum Quantity

Type	Standard Quantity [pcs]	
	Paper Tape	Embossed Tape
BR C1608	—	3,000
BR L2012	—	3,000
BR C2016	—	2,000
BR C2518	—	2,000
BR L2518	—	3,000
BRFL2518	—	3,000
BR L3225	—	2,000

② Tape Material

Embossed tape  
Card board carrier tape

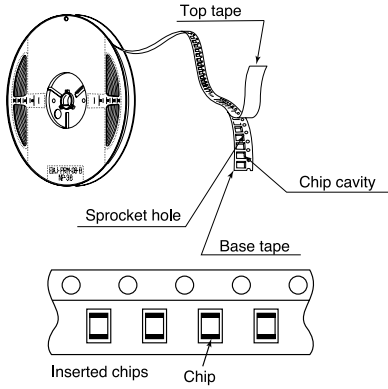

③ Taping dimensions

- Embossed Tape 8mm wide (0.315 inches wide)
- Card board carrier tape 8mm wide (0.315 inches wide)

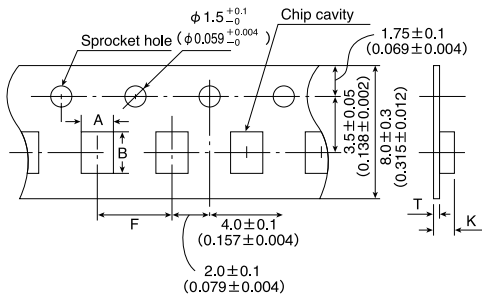

Type	Chip cavity		Insertion pitch	Tape thickness	
	A	B	F	T	K
BR C1608	1.0±0.10 (0.04±0.004)	1.9±1.0 (0.076±0.004)	4.0±0.1 (0.157±0.004)	0.25±0.05 (0.01±0.002)	1.2 max. (0.047)
BR L2012	1.40±0.1 (0.056±0.004)	2.2±0.1 (0.088±0.004)	4.0±0.1 (0.157±0.004)	0.25±0.05 (0.01±0.002)	1.2 max. (0.048)
BR C2016	1.75±0.1 (0.069±0.004)	2.1±0.1 (0.083±0.004)	4.0±0.1 (0.157±0.004)	0.3±0.05 (0.012±0.002)	1.9 max. (0.074)
BR C2518	2.15±0.1 (0.085±0.004)	2.7±0.1 (0.107±0.004)	4.0±0.1 (0.157±0.004)	0.3±0.05 (0.012±0.002)	2.2 max. (0.086)
BR L2518	2.3±0.1 (0.092±0.004)	2.8±0.1 (0.112±0.004)	4.0±0.1 (0.157±0.004)	0.3±0.05 (0.012±0.002)	1.45 max. (0.057)
BRFL2518	2.15±0.1 (0.085±0.004)	2.8±0.1 (0.112±0.004)	4.0±0.1 (0.157±0.004)	0.25±0.05 (0.01±0.002)	1.25 max. (0.049)
BR L3225	2.8±0.1 (0.112±0.004)	3.5±0.1 (0.140±0.004)	4.0±0.1 (0.157±0.004)	0.25±0.05 (0.01±0.002)	1.9 max. (0.074)

Unit : mm (inch)

④ Leader and Blank portion

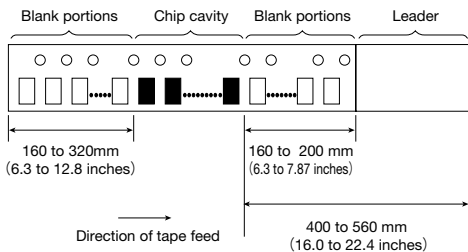

⑤ Reel size

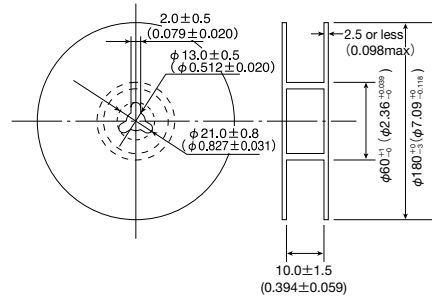

⑥ Top Tape Strength

The top tape requires a peel-off force of 0.2 to 0.7N in the direction of the arrow as illustrated below.

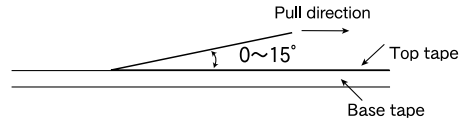

\* This catalog contains the typical specification only due to the limitation of space. When you consider purchase of our products, please check our specification. For details of each product (characteristics graph, reliability information, precautions for use, and so on), see our Web site (<http://www.ty-top.com/>) or CD catalogs.

## RELIABILITY DATA

1. Operating Temperature Range	
BRC1608, BRL2012, BRC2016, BRC2518, BRFL2518, BRL2518, BRL3225 Type	-25~+105°C
NR30/40/50/60/80, NRV30, NRG40, NRH24/30, NRS50/60 Type	-25~+120°C
NR10050 Type	-25~+105°C
【Test Method and Remarks】 Including self-generated heat	

2. Storage Temperature Range	
BRC1608, BRL2012, BRC2016, BRC2518, BRFL2518, BRL2518, BRL3225 Type	-40~+85°C
NR30/40/50/60/80, NRV30, NRG40, NRH24/30, NRS50/60 Type	
NR10050 Type	
【Test Method and Remarks】 BRC1608, BRL2012, BRC2016, BRC2518, BRFL2518, BRL2518, BRL3225 Type, NR30/40/50/60/80, NRV30, NRG40, NRH24/30, NRS50/60 Type : 0 to 40°C for the product with taping. NR10050 Type : 0~40°C for the product with taping.	

3. Rated current	
BRC1608, BRL2012, BRC2016, BRC2518, BRFL2518, BRL2518, BRL3225 Type	Within the specified tolerance
NR30/40/50/60/80, NRV30, NRG40, NRH24/30, NRS50/60 Type	
NR10050 Type	

4. Inductance	
BRC1608, BRL2012, BRC2016, BRC2518, BRFL2518, BRL2518, BRL3225 Type	Within the specified tolerance
NR30/40/50/60/80, NRV30, NRG40, NRH24/30, NRS50/60 Type	
NR10050 Type	
【Test Method and Remarks】 BRC1608, BRL2012, BRC2016, BRC2518, BRFL2518, BRL2518, BRL3225 Type : LCR Meter : HP 4285A or equivalent, Measuring frequency : Specified frequency NR30/40/50/60/80, NRV30, NRG40, NRH24/30, NRS50/60 Type : LCR Meter : HP 4285A or equivalent, 100KHz, 1V NR10050 Type : LCR Meter : HP 4263A or equivalent, 100KHz, 1V	

5. DC Resistance	
BRC1608, BRL2012, BRC2016, BRC2518, BRFL2518, BRL2518, BRL3225 Type	Within the specified tolerance
NR30/40/50/60/80, NRV30, NRG40, NRH24/30, NRS50/60 Type	
NR10050 Type	
【Test Method and Remarks】 DC ohmmeter : HIOKI 3227 or equivalent	

6. Self resonance frequency	
BRC1608, BRL2012, BRC2016, BRC2518, BRFL2518, BRL2518, BRL3225 Type	Within the specification
NR30/40/50/60/80, NRV30, NRG40, NRH24/30, NRS50/60 Type	
NR10050 Type	
【Test Method and Remarks】 BRC1608, BRL2012, BRC2016, BRC2518, BRFL2518, BRL2518, BRL3225 Type, NR30/40/50/60/80, NRV30, NRG40, NRH24/30, NRS50/60 Type, NR10050 Type : Impedance analyzer/material analyzer : HP4291A or equivalent HP4191A, 4192A or equivalent	

7. Temperature characteristic	
BRC1608, BRL2012, BRC2016, BRC2518, BRFL2518, BRL2518, BRL3225 Type	BRL2012, BRC2016, BRL2518, BRL3225, BRC2518, BRFL2518 Inductance change : Within $\pm 15\%$
NR30/40/50/60/80, NRV30, NRG40, NRH24/30, NRS50/60 Type	BRC1608 Inductance change : Within $\pm 20\%$
NR10050 Type	Inductance change : Within $\pm 20\%$

【Test Method and Remarks】  
BRC1608, BRL2012, BRC2016, BRC2518, BRFL2518, BRL2518, BRL3225 Type, NR30/40/50/60/80, NRV30, NRG40, NRH24/30, NRS50/60 Type, NR10050 Type :  
Measurement of inductance shall be taken at temperature range within  $-25^{\circ}\text{C}\sim+85^{\circ}\text{C}$ .  
With reference to inductance value at  $+20^{\circ}\text{C}$ ., change rate shall be calculated.

Change of maximum inductance deviation in step 1 to 5

Temperature at step 1	20°C
Temperature at step 2	Minimum operating temperature
Temperature at step 3	20°C (Standard temperature)
Temperature at step 4	Maximum operating temperature
Temperature at step 5	20°C

\* This catalog contains the typical specification only due to the limitation of space. When you consider purchase of our products, please check our specification.  
For details of each product (characteristics graph, reliability information, precautions for use, and so on), see our Web site (<http://www.ty-top.com/>) or CD catalogs.

## RELIABILITY DATA

### 8. Resistance to flexure of substrate

BRC1608, BRL2012, BRC2016, BRC2518, BRFL2518, BRL2518, BRL3225 Type	No damage.
NR30/40/50/60/80, NRV30, NRG40, NRH24/30, NRS50/60 Type	
NR10050 Type	

#### [Test Method and Remarks]

BRC1608, BRL2012, BRC2016, BRC2518, BRFL2518, BRL2518, BRL3225 Type, NR30/40/50/60/80, NRV30, NRG40, NRH24/30, NRS50/60 Type :

The test samples shall be soldered to the test board by the reflow. As illustrated below, apply force in the direction of the arrow indicating until deflection of the test board reaches to 2 mm.

Test board size : 100×40×1.0  
 Test board material : glass epoxy-resin  
 Solder cream thickness : 0.12 (BR Series)  
 0.10 (NR30/40, NRV30, NRH24/30, NRG40)  
 0.15 (NR50/60/80, NRS50/60)

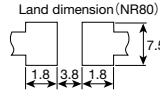
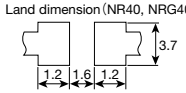
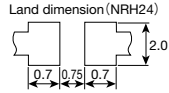
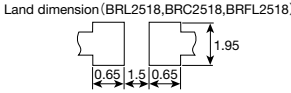
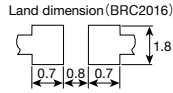
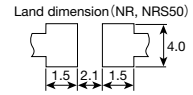
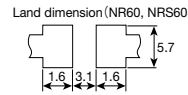
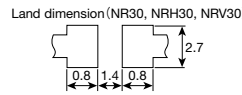
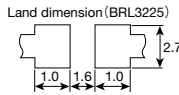
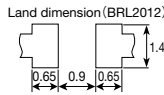
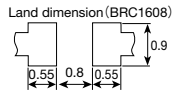
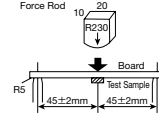

Printed board thickness : 1.0mm  
 Unit : mm

### 9. Insulation resistance : between wires

BRC1608, BRL2012, BRC2016, BRC2518, BRFL2518, BRL2518, BRL3225 Type	
NR30/40/50/60/80, NRV30, NRG40, NRH24/30, NRS50/60 Type	
NR10050 Type	

### 10. Insulation resistance : between wire and core

BRC1608, BRL2012, BRC2016, BRC2518, BRFL2518, BRL2518, BRL3225 Type	
NR30/40/50/60/80, NRV30, NRG40, NRH24/30, NRS50/60 Type	
NR10050 Type	

### 11. Withstanding voltage : between wires and core

BRC1608, BRL2012, BRC2016, BRC2518, BRFL2518, BRL2518, BRL3225 Type	
NR30/40/50/60/80, NRV30, NRG40, NRH24/30, NRS50/60 Type	
NR10050 Type	

### 12. Adhesion of terminal electrode

BRC1608, BRL2012, BRC2016, BRC2518, BRFL2518, BRL2518, BRL3225 Type	Shall not come off PC board.
NR30/40/50/60/80, NRV30, NRG40, NRH24/30, NRS50/60 Type	
NR10050 Type	

#### [Test Method and Remarks]

BRC2012, BRC2016, BRC2518, BRFL2518, BRL2518, BRL3225 Type, NR30/40/50/60/80, NRV30, NRG40, NRH24/30, NRS50/60 Type :

The test samples shall be soldered to the test board by the reflow.

- Applied force : 10N to X and Y directions.
- Duration : 5s.
- Solder cream thickness : 0.15mm.

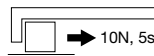

BRC1608, NR10050 Type :

- Applied force : 5N to X and Y directions.
- Duration : 5s.

### 13. Resistance to vibration

BRC1608, BRL2012, BRC2016, BRC2518, BRFL2518, BRL2518, BRL3225 Type	Inductance change : Within ±10% No significant abnormality in appearance.
NR30/40/50/60/80, NRV30, NRG40, NRH24/30, NRS50/60 Type	
NR10050 Type	

#### [Test Method and Remarks]

BRC1608, BRL2012, BRC2016, BRC2518, BRFL2518, BRL2518, BRL3225 Type, NR30/40/50/60/80, NRV30, NRG40, NRH24/30, NRS50/60 Type, NR10050 Type :

The test samples shall be soldered to the test board by the reflow.

Then it shall be submitted to below test conditions.

Frequency Range	10~55Hz	
Total Amplitude	1.5mm (May not exceed acceleration 196m/s <sup>2</sup> )	
Sweeping Method	10Hz to 55Hz to 10Hz for 1min.	
Time	X	For 2 hours on each X, Y, and Z axis.
	Y	
	Z	

Recovery : At least 2hrs of recovery under the standard condition after the test, followed by the measurement within 48hrs.

\* This catalog contains the typical specification only due to the limitation of space. When you consider purchase of our products, please check our specification. For details of each product (characteristics graph, reliability information, precautions for use, and so on), see our Web site (<http://www.ty-top.com/>) or CD catalogs.

## RELIABILITY DATA

### 14. Solderability

BRC1608, BRL2012, BRC2016, BRC2518, BRFL2518, BRL2518, BRL3225 Type	At least 90% of surface of terminal electrode is covered by new solder.
NR30/40/50/60/80, NRV30, NRG40, NRH24/30, NRS50/60 Type	
NR10050 Type	

#### [Test Method and Remarks]

BRC1608, BRL2012, BRC2016, BRC2518, BRFL2518, BRL2518, BRL3225 Type, NR30/40/50/60/80, NRV30, NRG40, NRH24/30, NRS50/60 Type, NR10050 Type :  
The test samples shall be dipped in flux, and then immersed in molten solder as shown in below table.  
Flux : Methanol solution containing rosin 25%.

NR30/40/50/60/80, NRV30, NRG40, NRH24/30, NRS50/60 Type :

Solder Temperature	245±5°C
Time	5±1.0 sec.

BRC1608, BRL2012, BRC2016, BRC2518, BRFL2518, BRL2518, BRL3225 Type :

Solder Temperature	245±5°C
Time	5±0.5 sec.

※Immersion depth : All sides of mounting terminal shall be immersed.

### 15. Resistance to soldering heat

BRC1608, BRL2012, BRC2016, BRC2518, BRFL2518, BRL2518, BRL3225 Type	Inductance change : Within ±10% No significant abnormality in appearance.
NR30/40/50/60/80, NRV30, NRG40, NRH24/30, NRS50/60 Type	
NR10050 Type	

#### [Test Method and Remarks]

BRC1608, BRL2012, BRC2016, BRC2518, BRFL2518, BRL2518, BRL3225 Type :  
3 times of reflow oven at 230°C MIN. for 40sec. with peak temperature at 260<sup>+0</sup><sub>-5</sub>°C for 5sec.

NR30/40/50/60/80, NRV30, NRG40, NRH24/30, NRS50/60 Type, NR10050 Type :  
The test sample shall be exposed to reflow oven at 230±5°C for 40 seconds, with peak temperature at 260±5°C for 5 seconds, 2 times.

NR6020 Type :

The test sample shall be exposed to reflow oven at 230±5°C for 40 seconds, with peak temperature at 250<sup>+0</sup><sub>-5</sub>°C for 5 seconds, 2 times.

Test board thickness : 1.0mm

Test board material : glass epoxy-resin

### 16. Thermal shock

BRC1608, BRL2012, BRC2016, BRC2518, BRFL2518, BRL2518, BRL3225 Type	Inductance change : Within ±10% No significant abnormality in appearance.
NR30/40/50/60/80, NRV30, NRG40, NRH24/30, NRS50/60 Type	
NR10050 Type	

#### [Test Method and Remarks]

BRC1608, BRL2012, BRC2016, BRC2518, BRFL2518, BRL2518, BRL3225 Type, NR30/40/50/60/80, NRV30, NRG40, NRH24/30, NRS50/60 Type, NR10050 Type :  
The test samples shall be soldered to the test board by the reflow. The test samples shall be placed at specified temperature for specified time by step 1 to step 4 as shown in below table in sequence. The temperature cycle shall be repeated 100 cycles.

Conditions of 1 cycle		
Step	Temperature (°C)	Duration (min)
1	-40±3	30±3
2	Room temperature	Within 3
3	+85±2	30±3
4	Room temperature	Within 3

### 17. Damp heat

BRC1608, BRL2012, BRC2016, BRC2518, BRFL2518, BRL2518, BRL3225 Type	Inductance change : Within ±10% No significant abnormality in appearance.
NR30/40/50/60/80, NRV30, NRG40, NRH24/30, NRS50/60 Type	
NR10050 Type	

#### [Test Method and Remarks]

BRC1608, BRL2012, BRC2016, BRC2518, BRFL2518, BRL2518, BRL3225 Type :

Temperature	60±2°C
Humidity	90~95%RH
Time	1000 hours.

Recovery : At least 2hrs of recovery under the standard condition after the test, followed by the measurement within 48 hrs.

NR30/40/50/60/80, NRV30, NRG40, NRH24/30, NRS50/60 Type :

The test samples shall be soldered to the test board by the reflow.

The test samples shall be placed in thermostatic oven set at specified temperature and humidity as shown in below table.

Temperature	60±2°C
Humidity	90~95%RH
Time	500±24hour

\* This catalog contains the typical specification only due to the limitation of space. When you consider purchase of our products, please check our specification.  
For details of each product (characteristics graph, reliability information, precautions for use, and so on), see our Web site (<http://www.ty-top.com/>) or CD catalogs.

## RELIABILITY DATA

### 18. Loading under damp heat

BRC1608, BRL2012, BRC2016, BRC2518, BRFL2518, BRL2518, BRL3225 Type	Inductance change : Within $\pm 10\%$ No significant abnormality in appearance.
NR30/40/50/60/80, NRV30, NRG40, NRH24/30, NRS50/60 Type	
NR10050 Type	

#### [Test Method and Remarks]

BRC1608, BRL2012, BRC2016, BRC2518, BRFL2518, BRL2518, BRL3225 Type :

Temperature	60 $\pm 2^{\circ}\text{C}$
Humidity	90~95%RH
Applied current	Rated current
Time	1000hours.

Recovery : At least 2hrs of recovery under the standard condition after the test, followed by the measurement within 48 hrs.

NR30/40/50/60/80, NRV30, NRG40, NRH24/30, NRS50/60 Type, NR10050 Type :

The test samples shall be soldered to the test board by the reflow.

The test samples shall be placed in thermostatic oven set at specified temperature and humidity and applied the rated current continuously as shown in below table.

Temperature	60 $\pm 2^{\circ}\text{C}$
Humidity	90~95%RH
Applied current	Rated current
Time	500 $\pm 2$ hour

### 19. Low temperature life test

BRC1608, BRL2012, BRC2016, BRC2518, BRFL2518, BRL2518, BRL3225 Type	Inductance change : Within $\pm 10\%$ No significant abnormality in appearance.
NR30/40/50/60/80, NRV30, NRG40, NRH24/30, NRS50/60 Type	
NR10050 Type	

#### [Test Method and Remarks]

BRC1608, BRL2012, BRC2016, BRC2518, BRFL2518, BRL2518, BRL3225 Type :

Temperature	-40 $\pm 2^{\circ}\text{C}$
Duration	1000hours

Recovery : At least 2hrs of recovery under the standard condition after the test, followed by the measurement within 48 hrs.

NR30/40/50/60/80, NRV30, NRG40, NRH24/30, NRS50/60 Type, NR10050 Type :

The test samples shall be soldered to the test board by the reflow.

After that, the test samples shall be placed at test conditions as shown in below table.

Temperature	-40 $\pm 3^{\circ}\text{C}$
Time	500 $\pm 24$ hour

### 20. High temperature life test

BRC1608, BRL2012, BRC2016, BRC2518, BRFL2518, BRL2518, BRL3225 Type	Inductance change : Within $\pm 10\%$ No significant abnormality in appearance.
NR30/40/50/60/80, NRV30, NRG40, NRH24/30, NRS50/60 Type	
NR10050 Type	Inductance change : Within $\pm 10\%$ No significant abnormality in appearance.

#### [Test Method and Remarks]

BRC1608, BRL2012, BRC2016, BRC2518, BRFL2518, BRL2518, BRL3225 Type :

Temperature	85 $\pm 2^{\circ}\text{C}$
Duration	1000hours

Recovery : At least 2hrs of recovery under the standard condition after the test, followed by the measurement within 48 hrs.

NR10050 Type :

Temperature	105 $\pm 3^{\circ}\text{C}$
Time	500 $\pm 24$ hour

Recovery : At least 2hrs of recovery under the standard condition after the test, followed by the measurement within 48 hrs.

### 21. Loading at high temperature life test

BRC1608, BRL2012, BRC2016, BRC2518, BRFL2518, BRL2518, BRL3225 Type	Inductance change : Within $\pm 10\%$ No significant abnormality in appearance.
NR30/40/50/60/80, NRV30, NRG40, NRH24/30, NRS50/60 Type	
NR10050 Type	

#### [Test Method and Remarks]

NR30/40/50/60/80, NRV30, NRG40, NRH24/30, NRS50/60 Type :

The test samples shall be soldered to the test board by the reflow soldering.

Temperature	85 $\pm 2^{\circ}\text{C}$
Applied current	Rated current
Time	500 $\pm 24$ hour

### 22. Standard condition

BRC1608, BRL2012, BRC2016, BRC2518, BRFL2518, BRL2518, BRL3225 Type	Standard test condition : Unless otherwise specified, temperature is 20 $\pm 15\%$ and 65 $\pm 20\%$ of relative humidity. When there are question concerning measurement result : In order to provide correlation date, the test shall be condition of 20 $\pm 2^{\circ}\text{C}$ of temperature, 65 $\pm 5\%$ relative humidity. Inductance is in accordance with our measured value.
NR30/40/50/60/80, NRV30, NRG40, NRH24/30, NRS50/60 Type	
NR10050 Type	

\* This catalog contains the typical specification only due to the limitation of space. When you consider purchase of our products, please check our specification.  
For details of each product (characteristics graph, reliability information, precautions for use, and so on), see our Web site (<http://www.ty-top.com/>) or CD catalogs.

## PRECAUTIONS

### SMD Inductors

#### 1. Circuit Design

Precautions	<ul style="list-style-type: none"> <li>◆ Operating environment           <ol style="list-style-type: none"> <li>1. The products described in this specification are intended for use in general electronic equipment, (office supply equipment, telecommunications systems, measuring equipment, and household equipment). They are not intended for use in mission-critical equipment or systems requiring special quality and high reliability (traffic systems, safety equipment, aerospace systems, nuclear control systems and medical equipment including life-support systems,) where product failure might result in loss of life, injury or damage. For such uses, contact TAIYO YUDEN Sales Department in advance.</li> </ol> </li> </ul>
-------------	---

#### 2. PCB Design

Precautions	<ul style="list-style-type: none"> <li>◆ Land pattern design           <ol style="list-style-type: none"> <li>1. Please refer to a recommended land pattern.</li> </ol> </li> </ul>
Technical considerations	<ul style="list-style-type: none"> <li>◆ Land pattern design           <ul style="list-style-type: none"> <li>Surface Mounting</li> <li>• Mounting and soldering conditions should be checked beforehand.</li> <li>• Applicable soldering process to this products is reflow soldering only.</li> </ul> </li> </ul>

#### 3. Considerations for automatic placement

Precautions	<ul style="list-style-type: none"> <li>◆ Adjustment of mounting machine           <ol style="list-style-type: none"> <li>1. Excessive impact load should not be imposed on the products when mounting onto the PC boards.</li> <li>2. Mounting and soldering conditions should be checked beforehand.</li> </ol> </li> </ul>
Technical considerations	<ul style="list-style-type: none"> <li>◆ Adjustment of mounting machine           <ol style="list-style-type: none"> <li>1. When installing products, care should be taken not to apply distortion stress as it may deform the products.</li> </ol> </li> </ul>

#### 4. Soldering

Precautions	<ul style="list-style-type: none"> <li>◆ Reflow soldering           <ol style="list-style-type: none"> <li>1. Please contact any of our offices for a reflow soldering, and refer to the recommended condition specified.</li> <li>2. This products is reflow soldering only.</li> <li>3. Please do not add any stress to a product until it returns in normal temperature after reflow soldering.</li> </ol> </li> <li>◆ Lead free soldering           <ol style="list-style-type: none"> <li>1. When using products with lead free soldering, we request to use them after confirming of adhesion, temperature of resistance to soldering heat, soldering etc sufficiently.</li> </ol> </li> <li>◆ Recommended conditions for using a soldering iron (NR10050 Type)           <ul style="list-style-type: none"> <li>• Put the soldering iron on the land-pattern.</li> <li>• Soldering iron's temperature - Below 350°C</li> <li>• Duration - 3 seconds or less</li> <li>• The soldering iron should not directly touch the inductor.</li> </ul> </li> </ul>		
Technical considerations	<ul style="list-style-type: none"> <li>◆ Reflow soldering           <ol style="list-style-type: none"> <li>1. If products are used beyond the range of the recommended conditions, heat stresses may deform the products, and consequently degrade the reliability of the products.</li> </ol> </li> </ul>	<ul style="list-style-type: none"> <li>• BRC1608, BRL2012, BRL2518, BRC2016, BRL3225 Type BRC2518, BRFL2518</li> <li>Recommended reflow condition (Pb free solder)</li> </ul>	<ul style="list-style-type: none"> <li>• NR30/40/50/60/80, NRV30, NRG40, NRH24/30, NRS50/60 Type</li> <li>Recommended reflow condition (Pb free solder)</li> </ul>
			<ul style="list-style-type: none"> <li>• NR10050 Type</li> <li>Recommended reflow condition (Pb free solder)</li> </ul>

#### 5. Cleaning

Precautions	<ul style="list-style-type: none"> <li>◆ Cleaning conditions           <ol style="list-style-type: none"> <li>1. Washing by supersonic waves shall be avoided.</li> </ol> </li> </ul>
Technical considerations	<ul style="list-style-type: none"> <li>◆ Cleaning conditions           <ol style="list-style-type: none"> <li>1. If washing by supersonic waves, supersonic waves may cause broken products.</li> </ol> </li> </ul>

#### 6. Handling

Precautions	<ul style="list-style-type: none"> <li>◆ Handling           <ol style="list-style-type: none"> <li>1. Keep the product away from all magnets and magnetic objects.</li> </ol> </li> <li>◆ Breakaway PC boards (splitting along perforations)           <ol style="list-style-type: none"> <li>1. When splitting the PC board after mounting product, care should be taken not to give any stresses of deflection or twisting to the board.</li> <li>2. Board separation should not be done manually, but by using the appropriate devices.</li> </ol> </li> <li>◆ Mechanical considerations           <ol style="list-style-type: none"> <li>1. Please do not give the product any excessive mechanical shocks.</li> <li>2. Please do not add any shock and power to a product in transportation.</li> </ol> </li> <li>◆ Pick-up pressure           <ol style="list-style-type: none"> <li>1. Please do not push to add any pressure to a winding part. Please do not give any shock and push into a ferrite core exposure part..</li> </ol> </li> <li>◆ Packing           <ol style="list-style-type: none"> <li>1. Please avoid accumulation of a packing box as much as possible.</li> </ol> </li> </ul>
Technical considerations	<ul style="list-style-type: none"> <li>◆ Breakaway PC boards (splitting along perforations)           <ol style="list-style-type: none"> <li>1. Planning pattern configurations and the position of products should be carefully performed to minimize stress.</li> </ol> </li> <li>◆ Mechanical considerations           <ol style="list-style-type: none"> <li>1. There is a case to be damaged by a mechanical shock.</li> <li>2. There is a case to be broken by the handling in transportation.</li> </ol> </li> <li>◆ Pick-up pressure           <ol style="list-style-type: none"> <li>1. Damage and a characteristic can vary with an excessive shock or stress.</li> </ol> </li> <li>◆ Packing           <ol style="list-style-type: none"> <li>1. There is a case that transformation and a product of tape are damaged by accumulation of a packing box.</li> </ol> </li> </ul>

#### 7. Storage conditions

Precautions	<ul style="list-style-type: none"> <li>◆ Storage           <ol style="list-style-type: none"> <li>1. To maintain the solderability of terminal electrodes and to keep the packing material in good condition, temperature and humidity in the storage area should be controlled.               <ul style="list-style-type: none"> <li>• Recommended conditions</li> <li>Ambient temperature: 0~40°C</li> <li>Humidity : Below 70% RH</li> </ul> </li> </ol> <p>The ambient temperature must be kept below 30°C. Even under ideal storage conditions, solderability of products electrodes may decrease as time passes. For this reason, product should be used within 6 months from the time of delivery. In case of storage over 6 months, solderability shall be checked before actual usage.</p> </li></ul>
Technical considerations	<ul style="list-style-type: none"> <li>◆ Storage           <ol style="list-style-type: none"> <li>1. Under a high temperature and humidity environment, problems such as reduced solderability caused by oxidation of terminal electrodes and deterioration of taping/packaging materials may take place.</li> </ol> </li> </ul>

\* This catalog contains the typical specification only due to the limitation of space. When you consider purchase of our products, please check our specification. For details of each product (characteristics graph, reliability information, precautions for use, and so on), see our Web site (<http://www.ty-top.com/>) or CD catalogs.