

IRS21853SPBF

DUAL HIGH SIDE DRIVER IC

Features

- Gate drive supply range from 10 V to 20 V
- Under voltage lockout for V_{CC} & $V_{BS1,2}$
- 5 V input logic compatible
- Tolerant to negative transient voltage
- Matched propagation delays for all channels
- RoHS compliant

Descriptions

The IRS21853 is a high voltage, high speed power MOSFET and IGBT dual high-side driver with propagation delay matched output channels. Proprietary HVIC and latch immune CMOS technologies enable ruggedized monolithic construction. The floating logic input is compatible with standard CMOS or LSTTL output, down to 3.3 V logic and can be operated up to 600 V above the ground. The output driver features a high pulse current buffer stage designed for minimum driver cross-conduction. The floating channel can be used to drive an N-channel power MOSFET or IGBT in the high-side configuration, which operates up to 600 V.

Product Summary

V_{OFFSET}	600 V max
V_{OUT}	10 V to 20 V
t_{on}/t_{off} (typ)	170 ns/170 ns
$I_{o+/-}$	2 A/2 A
Delay Matching	40 ns

Package



16-Lead SOIC (narrow body)

Typical Connection Diagram

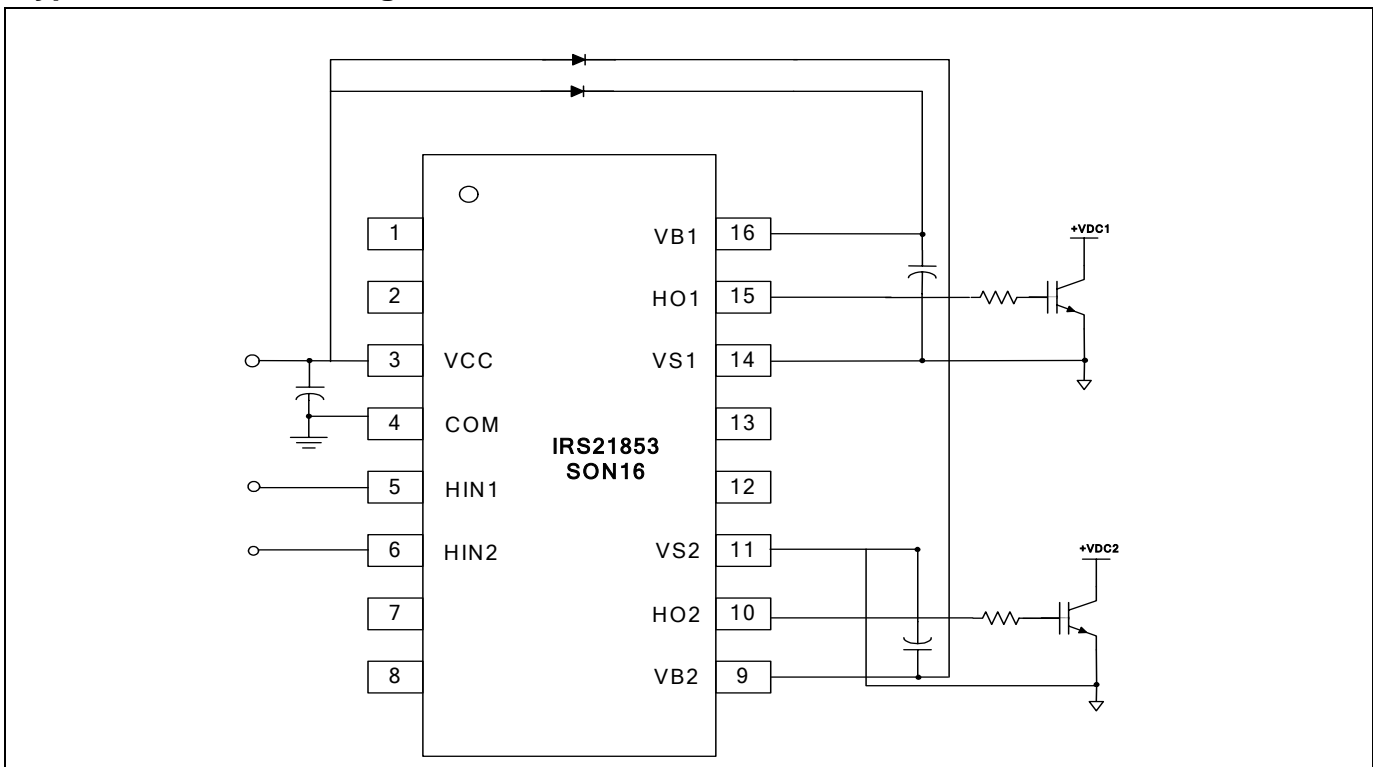

Typical Connection Diagram for ER Circuit in PDP

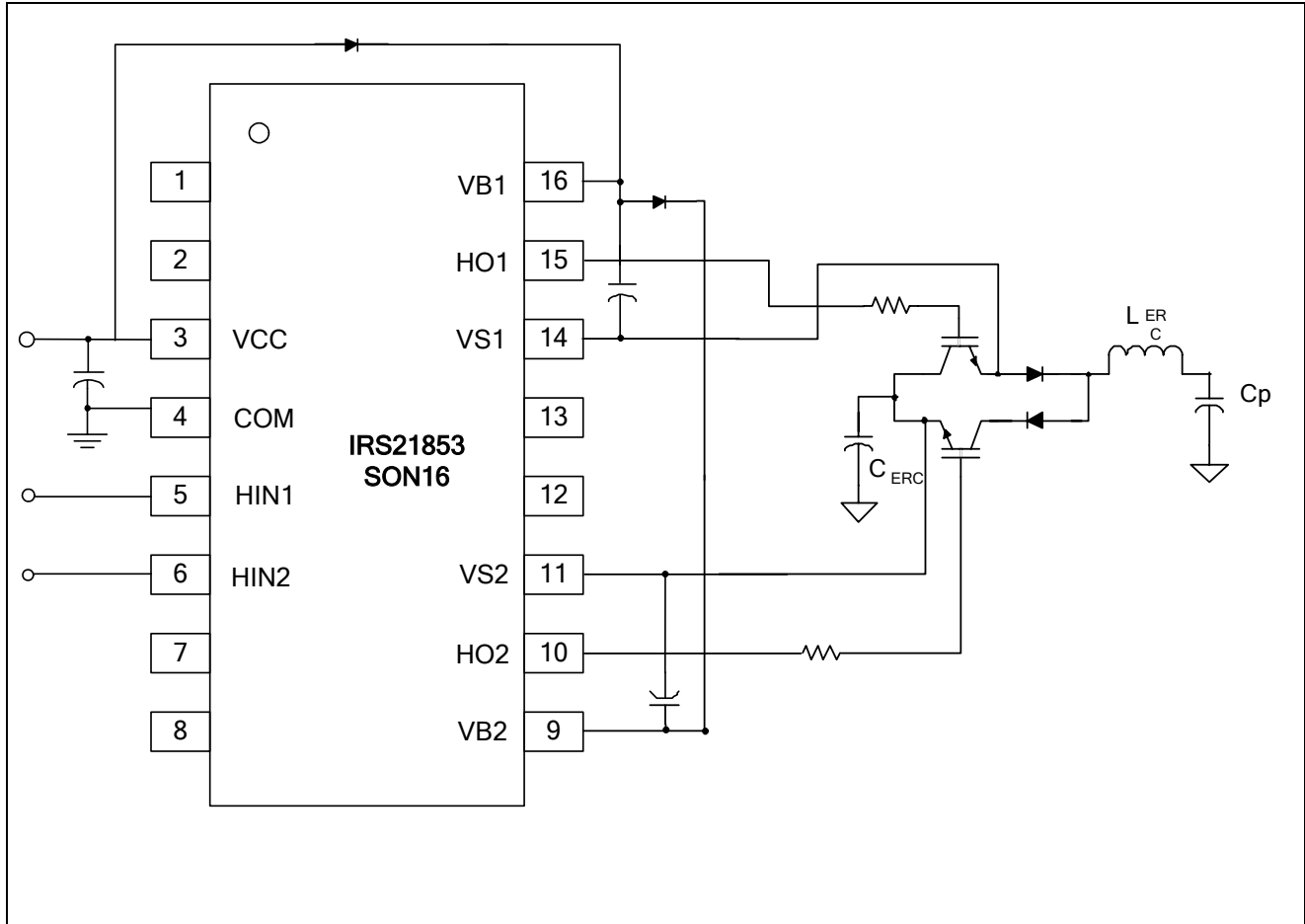

Absolute Maximum Ratings

Absolute maximum ratings indicate sustained limits beyond which damage to the device may occur. All voltage parameters are absolute voltages referenced to COM.

Symbol	Definition	Min	Max	Units
V_{CC}	Low side supply voltage	-0.3	20 (Note1)	V
V_{IN}	Logic input voltage (HIN1,2)	COM-0.3	$V_{CC}+0.3$	
$V_{B1,2}$	High side floating well supply voltage	-0.3	620 (Note1)	
$V_{S1,2}$	High side floating well supply return voltage	$V_{B1,2}-20$	$V_{Bn}+0.3$	
$V_{HO1,2}$	Floating gate drive output voltage	$V_{S1,2}-0.3$	$V_{Bn}+0.3$	
dV_S/dt	Allowable $V_{S1,2}$ offset supply transient relative to COM	-	50	V/ns
P_D	Package power dissipation @ $T_A \leq +25$ °C	-	1.25	W
$R_{\theta JA}$	Thermal resistance, junction to ambient	-	100	°C/W
T_J	Junction temperature	-55	150	°C
T_S	Storage temperature			
T_L	Lead temperature (soldering, 10 seconds)			
		-	300	

Note1: All supplies are fully tested at 25 V. An internal 20 V clamp exists for each supply.

Recommended Operating Conditions

For proper operation, the device should be used within the recommended conditions. All voltage parameters are absolute voltages referenced to COM. The offset rating are tested with supplies of $(V_{CC}-COM)=(V_{B1,2}-V_{S1,2})=15$ V.

Symbol	Definition	Min	Max	Units
V_{CC}	Low side supply voltage	10	20	V
V_{IN}	HIN1, 2 input voltage	COM	VCC	
$V_{B1,2}$	High side floating well supply voltage	$V_{S1,2}+10$	$V_{S1,2}+20$	
$V_{S1,2}$	High side floating well supply offset voltage	Note 2	600	
$V_{HO1,2}$	Floating gate drive output voltage	$V_{S1,2}$	$V_{B1,2}$	
T_A	Ambient temperature	-40	125	°C

Note 2: $V_{S1,2}$ and $V_{B1,2}$ voltages will be tolerant to short negative transient spikes. These will be defined and specified in the future.

Note 3: Logic operation for V_S of -5 V to 600 V. Logic state held for V_S of -5 V to $-V_{BS1,2}$. (Please refer to Design Tip DT97-3 for more details).

Static Electrical Characteristics

(V_{CC-COM})=($V_{B1,2}$ - $V_{S1,2}$)=15 V. $T_A = 25\text{ }^\circ\text{C}$ unless otherwise specified. The V_{IN} , $V_{IN,TH}$, and I_{IN} parameters are referenced to COM. The V_O and I_O parameters are referenced to respective $V_{S1,2}$ and are applicable to the respective output leads HO1,2. The V_{CCUV} parameters are referenced to COM. The $V_{BSUV1,2}$ parameters are referenced to $V_{S1,2}$.

Symbol	Definition	Min	Typ	Max	Units	Test Conditions	
V_{CCUV+}	V_{CC} supply undervoltage positive going threshold	8.0	8.9	9.8	V		
V_{CCUV-}	V_{CC} supply undervoltage negative going threshold	7.4	8.2	9.0			
V_{BSUV+}	$V_{BS1,2}$ supply undervoltage positive going threshold	8.0	8.9	9.8			
V_{BSUV-}	$V_{BS1,2}$ supply undervoltage negative going threshold	7.4	8.2	9.0			
$I_{LK1,2}$	High-side floating well offset supply leakage current	---	---	50	μA	$V_{B1,2} = V_{S1,2} = 600\text{ V}$	
I_{QBS}	Quiescent V_{BS} supply current	---	75	150		$HIN1,2 = 0\text{ V or }5\text{ V}$	
I_{QCC}	Quiescent V_{CC} supply current	---	110	220			
V_{IH}	Logic "1" input voltage	3.5	---	---	V		
V_{IL}	Logic "0" input voltage	---	---	0.6			
V_{OH}	HO1,2 high level output voltage, $V_{BIAS}-V_O$	---	---	1.4			$I_o = 0\text{ A}$
V_{OL}	HO1,2 low level output voltage, V_O	---	---	0.0 6			$I_o = 20\text{ mA}$
I_{IN+}	Logic "1" input bias current	---	5	20	μA	$V_{HIN1,2} = 5\text{ V}$	
I_{IN-}	Logic "0" input bias current	---	---	5		$V_{HIN1,2} = 0\text{ V}$	
I_{O+}	Output high short circuit pulsed current HO1,2	---	2	---	A	$V_O = 0\text{ V}, V_{IN} = 0\text{ V}, PW \leq 10\text{ }\mu\text{s}$	
I_{O-}	Output low short circuit pulsed current HO1,2	---	2	---		$V_O = 15\text{ V}, V_{IN} = 5\text{ V}, PW \leq 10\text{ }\mu\text{s}$	

Dynamic Electrical Characteristics (All values are target data)

(V_{CC-COM}) = ($V_{B1,2} - V_{S1,2}$) = 15 V. $T_A = 25\text{ }^\circ\text{C}$ unless otherwise specified. $C_L = 1000\text{ pF}$ unless otherwise specified. All parameters are reference to COM.

Symbol	Definition	Min	Typ	Max	Units	Test Conditions
t_{on}	Turn-on propagation delay (HO1,2)	---	170	---	ns	($V_{S1,2-COM}$)=0 V
t_{off}	Turn-off propagation delay (HO1,2)	---	170	---		($V_{S1,2-COM}$)=600 V
t_r	Turn-on rise time	---	15	50		
t_f	Turn-off fall time	---	15	50		
MT	Delay matching (Note 1)	---	---	40		

Note 4: $\text{Max}(t_{on,HO1}, t_{on,HO2}) - \text{Min}(t_{on,HO1}, t_{on,HO2})$; $\text{Max}(t_{off,HO1}, t_{off,HO2}) - \text{Min}(t_{off,HO1}, t_{off,HO2})$

Functional Block Diagram

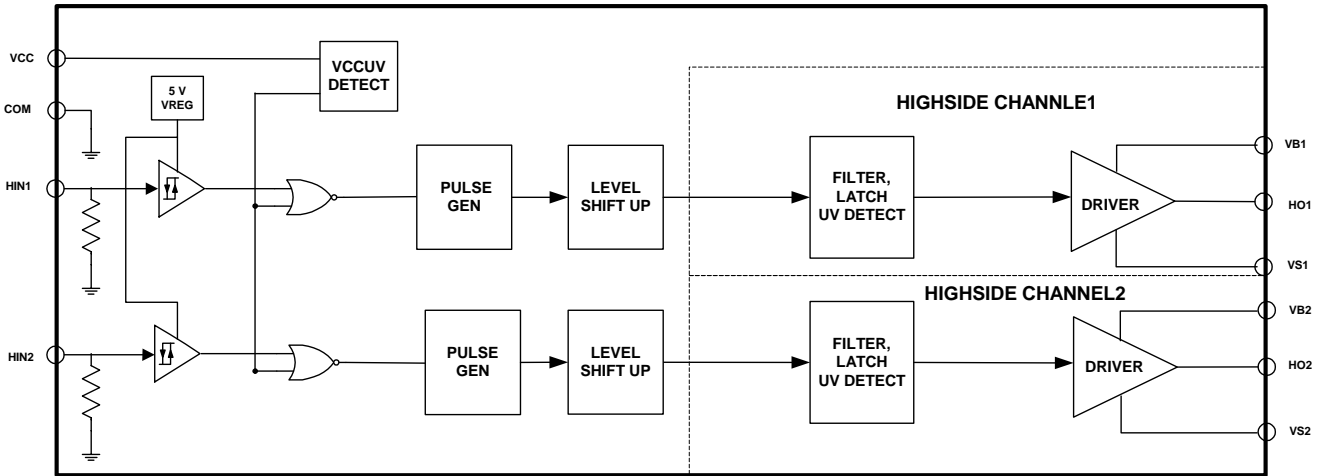

Lead Definitions

Symbol	Description
VCC	Low side supply voltage
COM	Ground
VB1,2	High side gate drive floating supply
HO1,2	High side driver outputs
VS1,2	High voltage floating supply return
HIN1,2	Logic inputs for high side gate driver outputs (in phase)

Lead Assignments

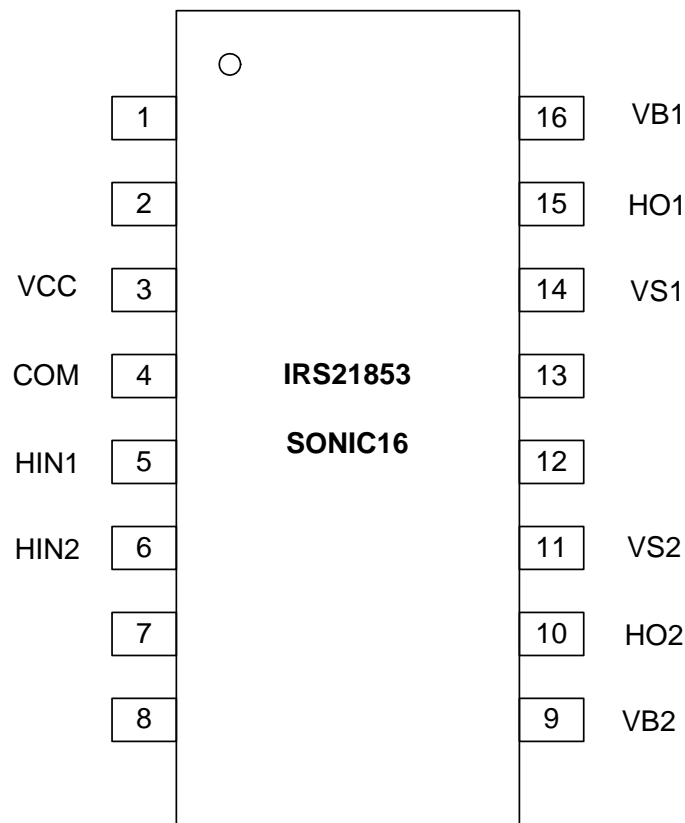

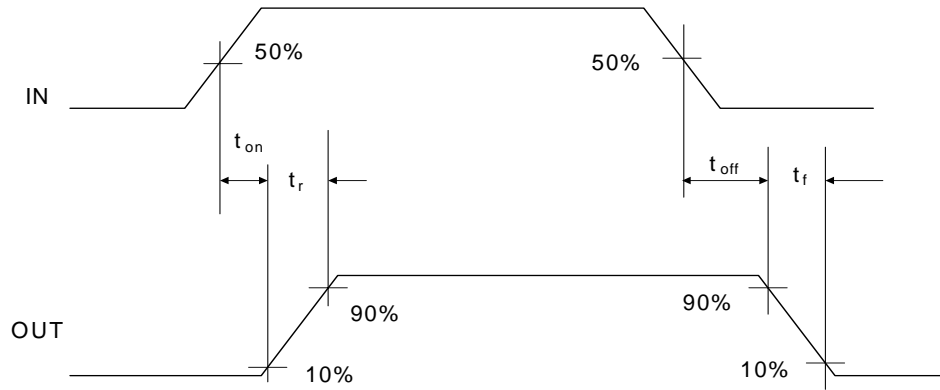

Figure 1: Switching Time Waveforms

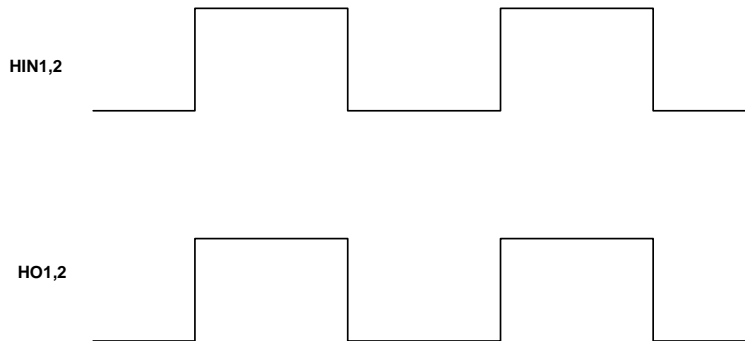
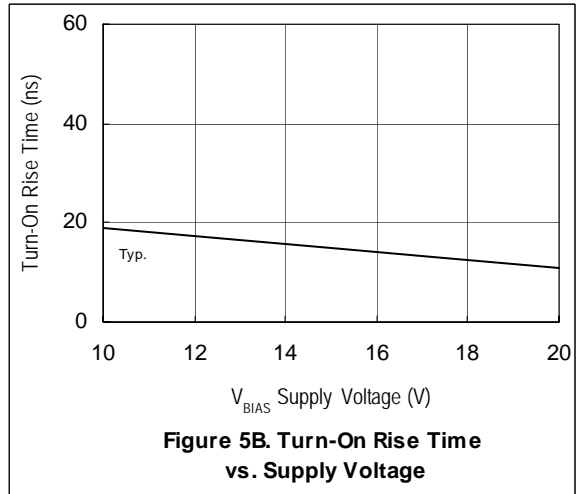
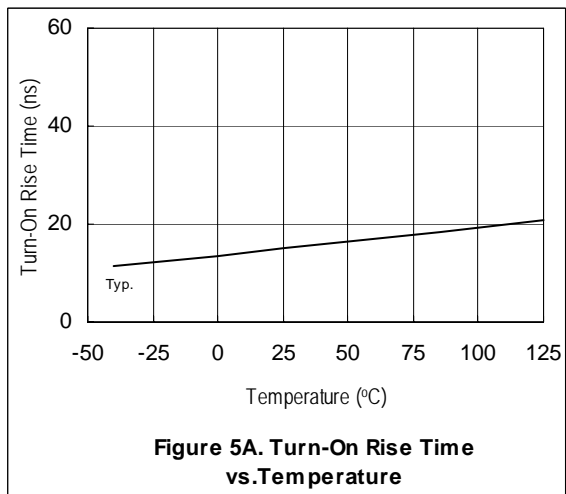
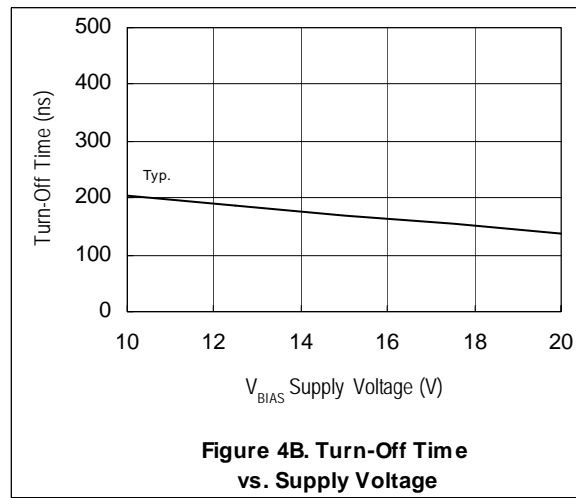
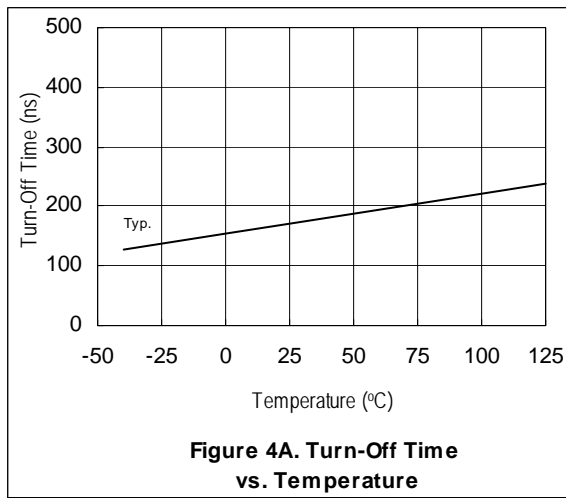
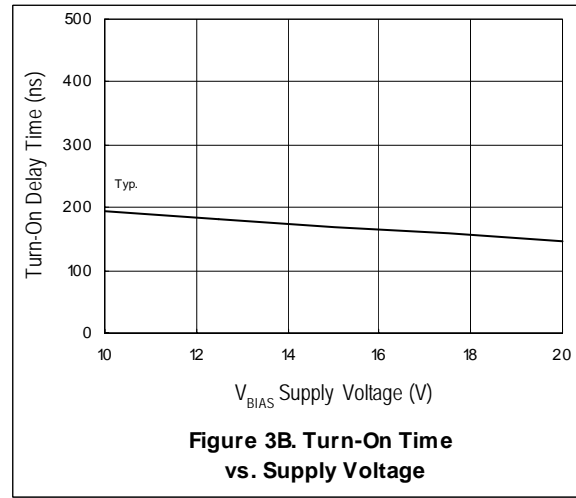
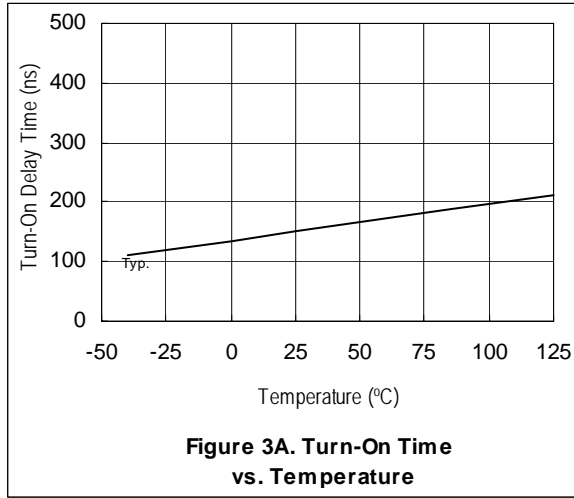
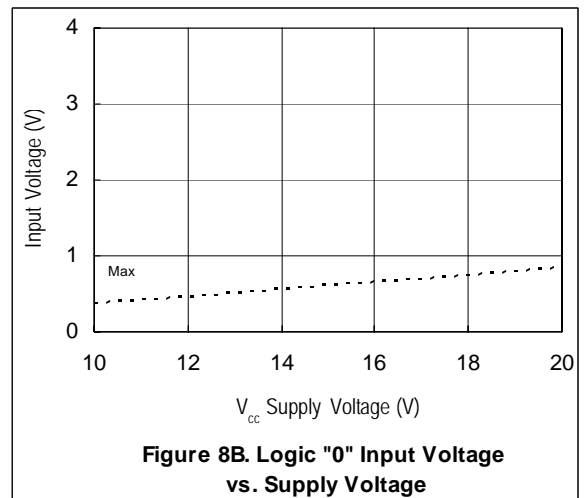
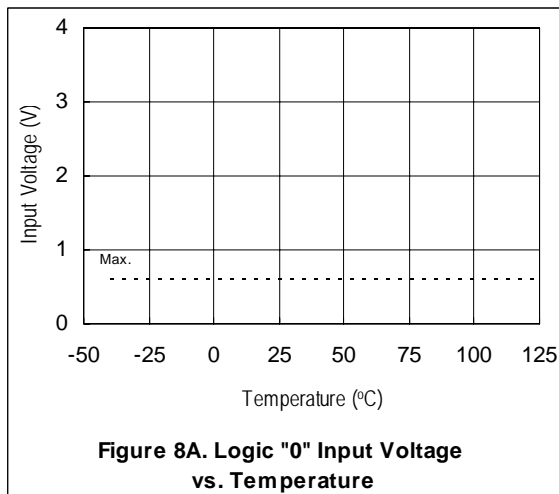
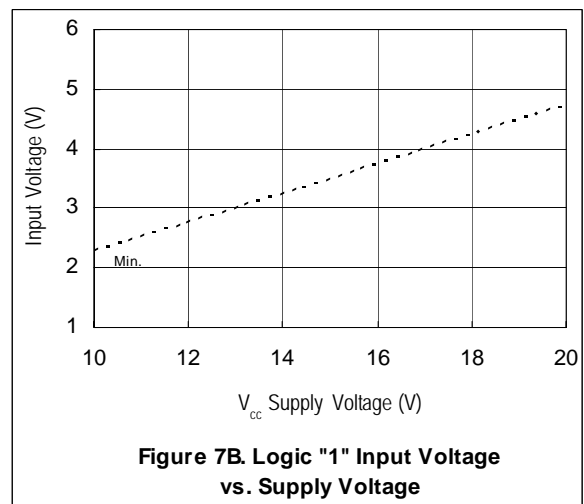
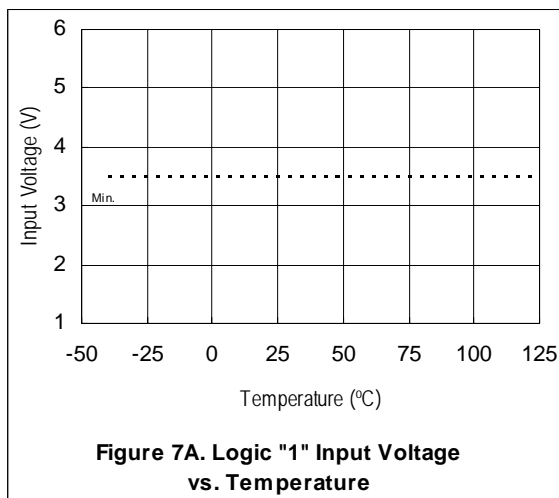
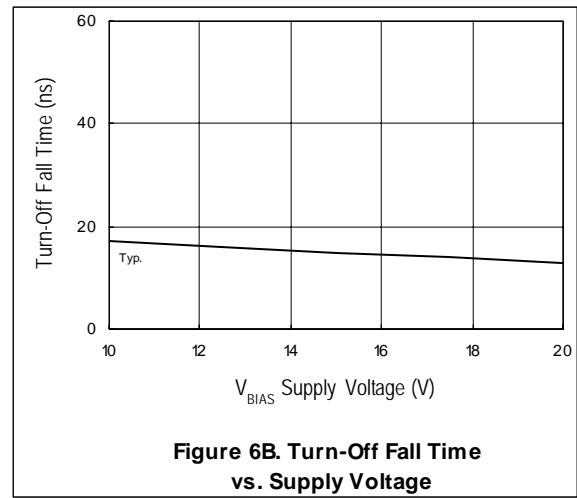
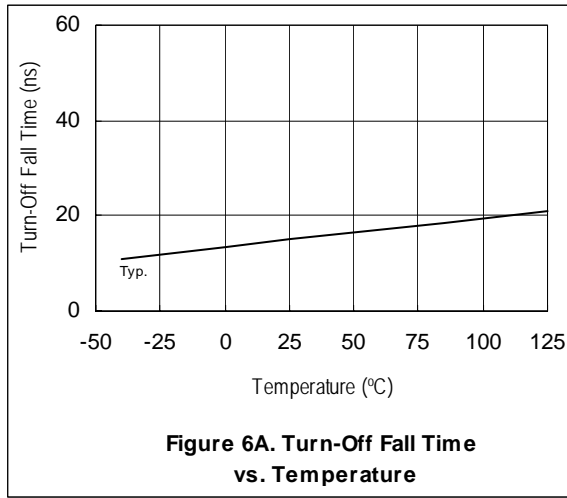
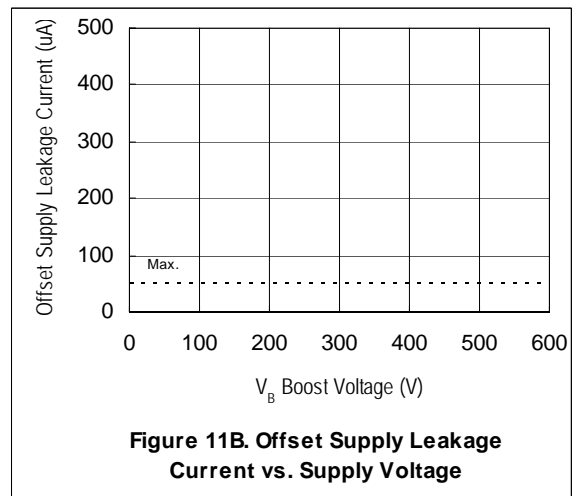
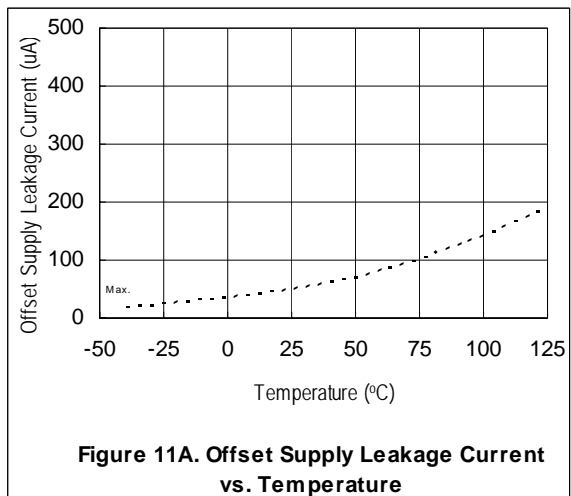
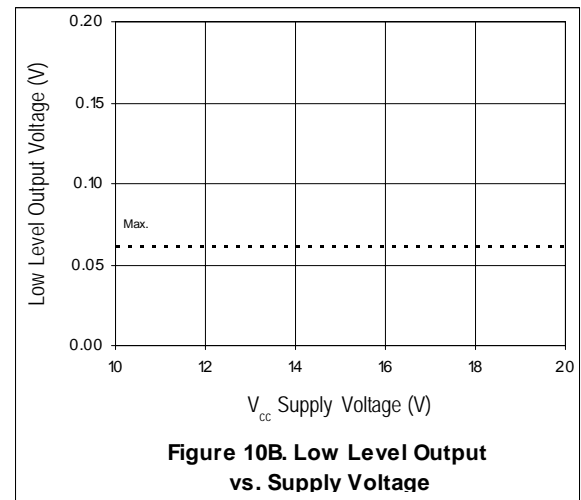
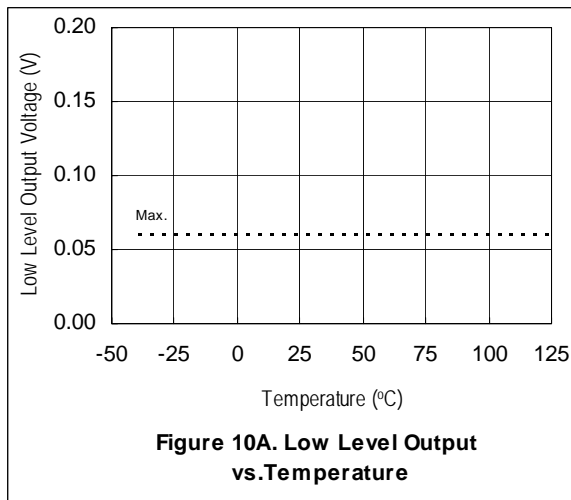
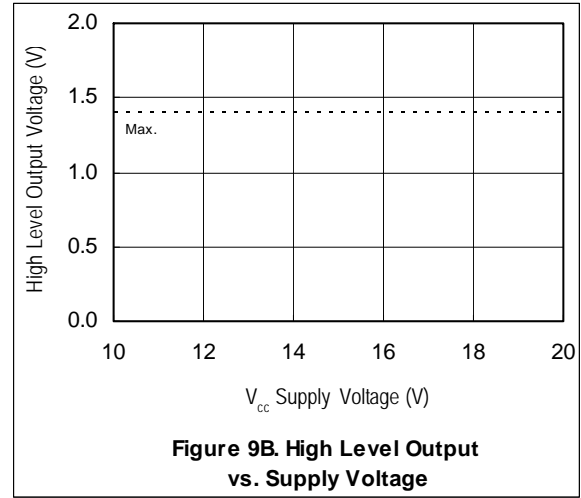
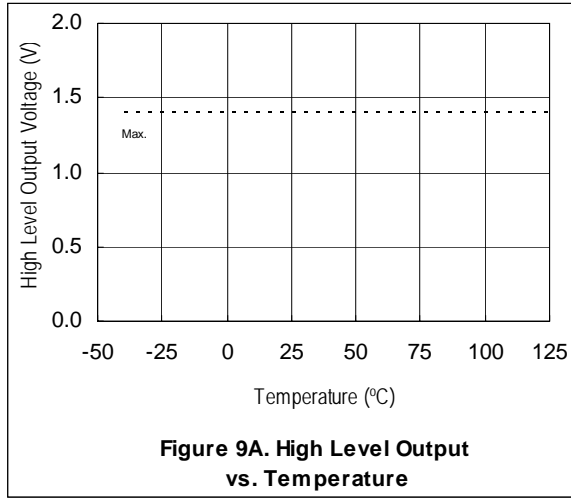
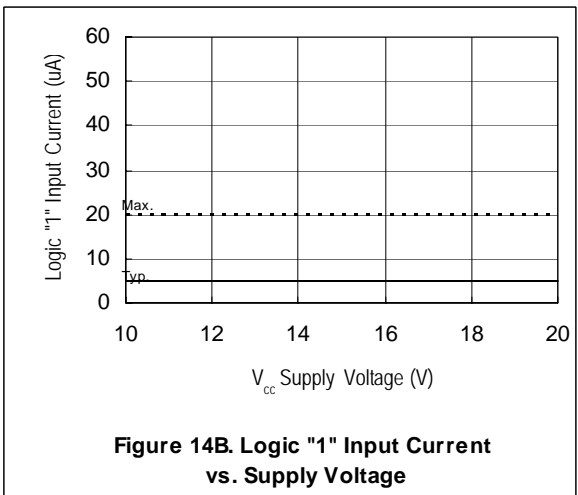
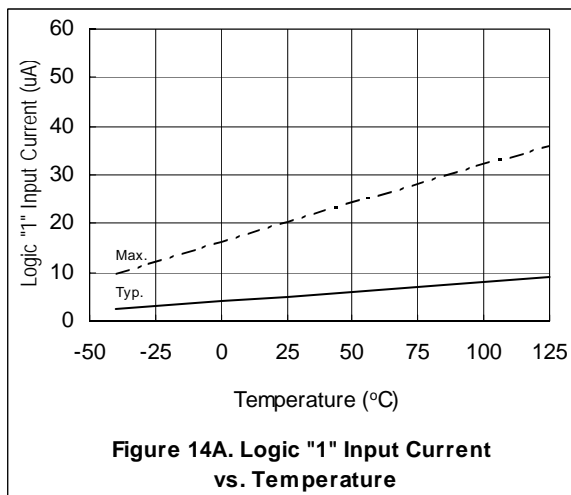
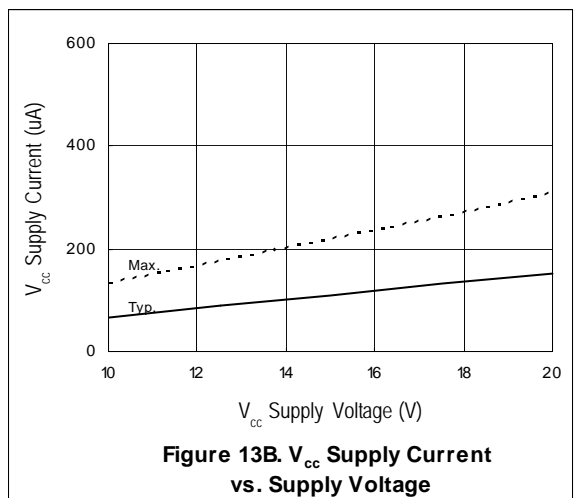
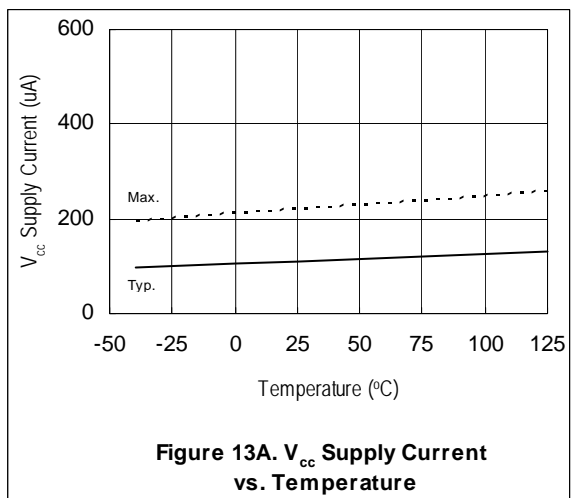
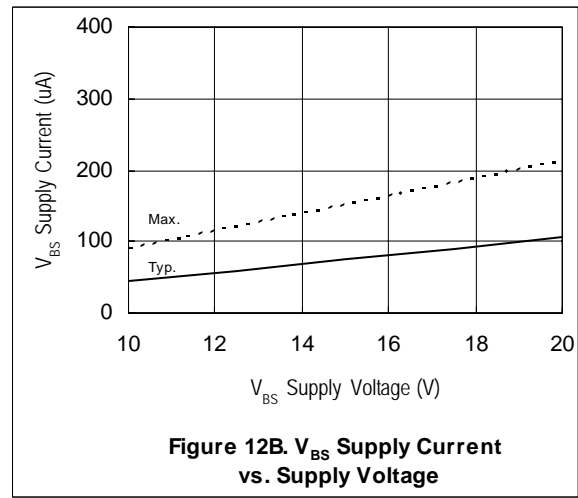
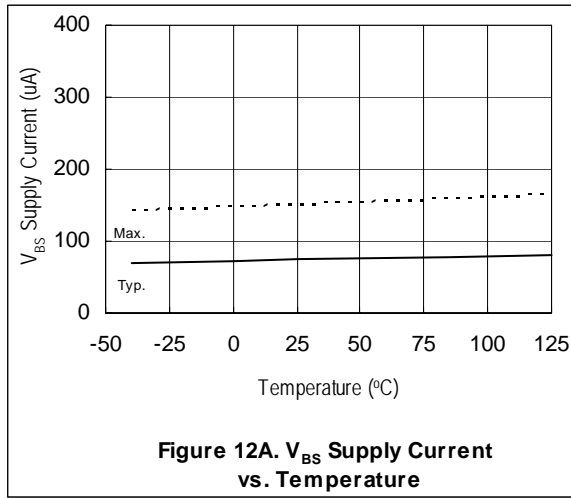

Figure 2: Input/Output Timing Diagram









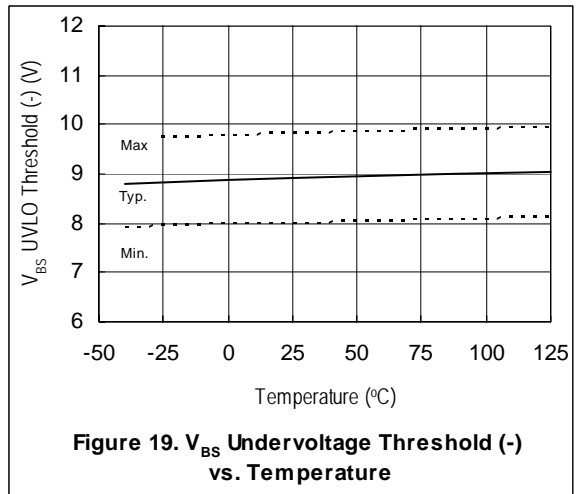
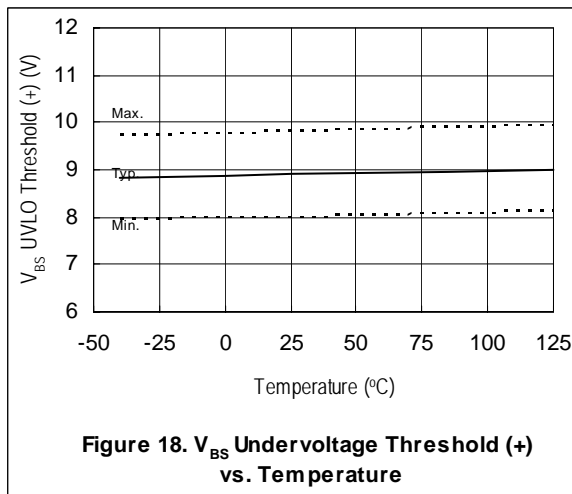
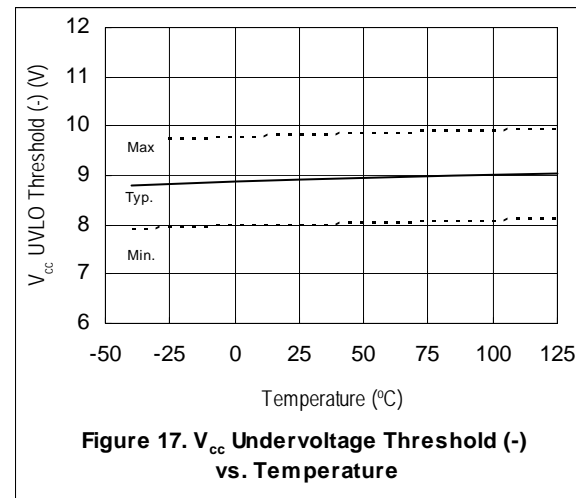
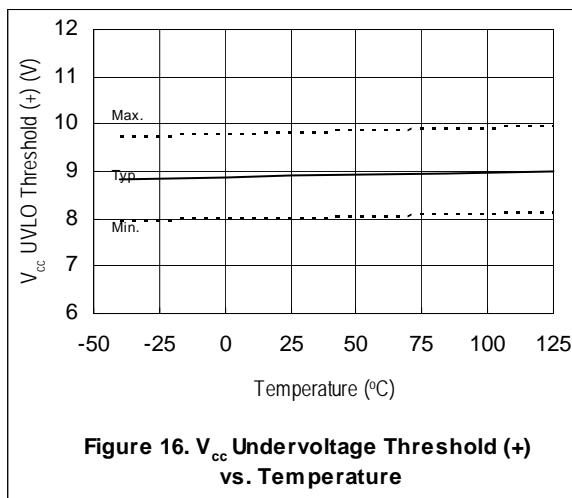
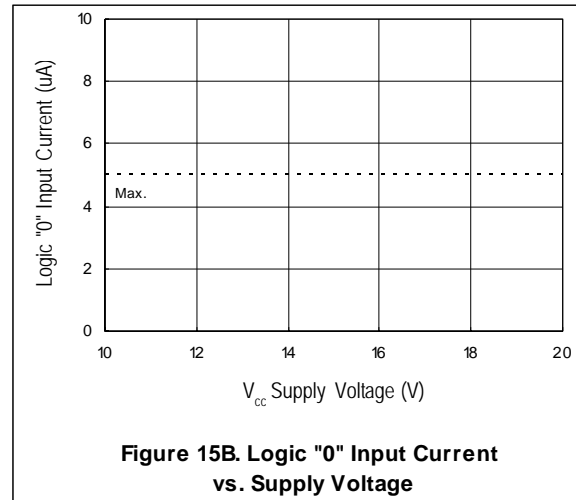
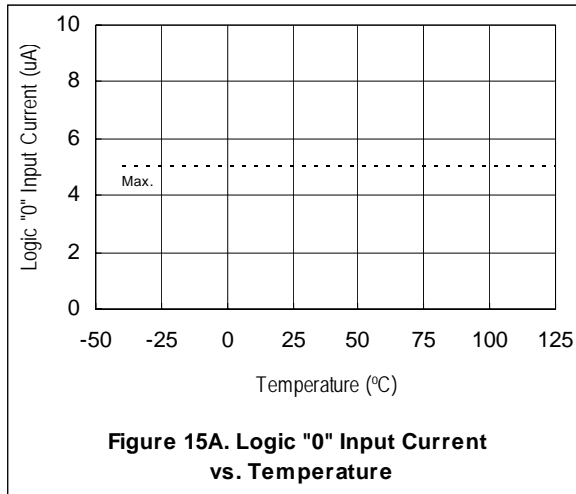

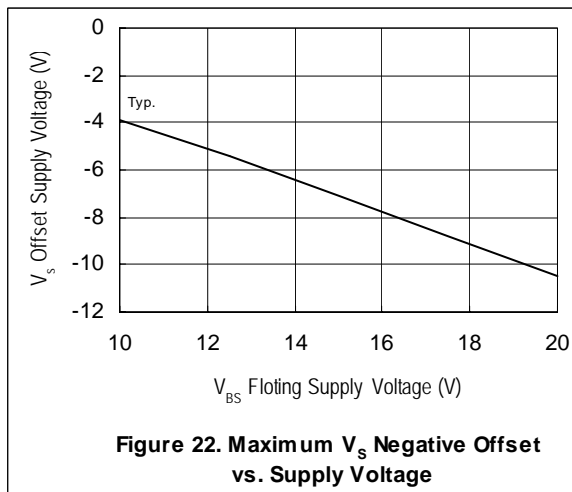
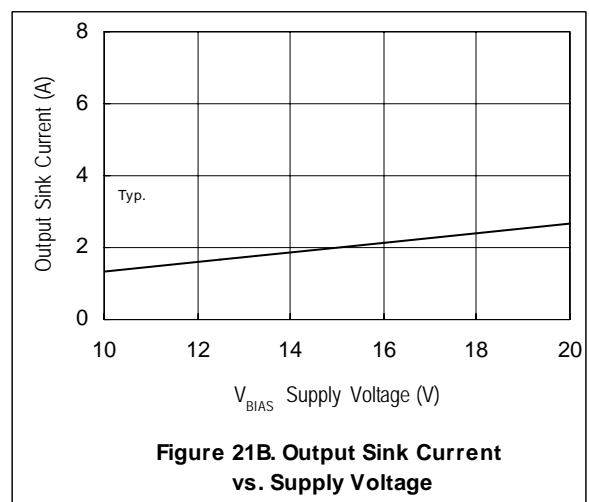
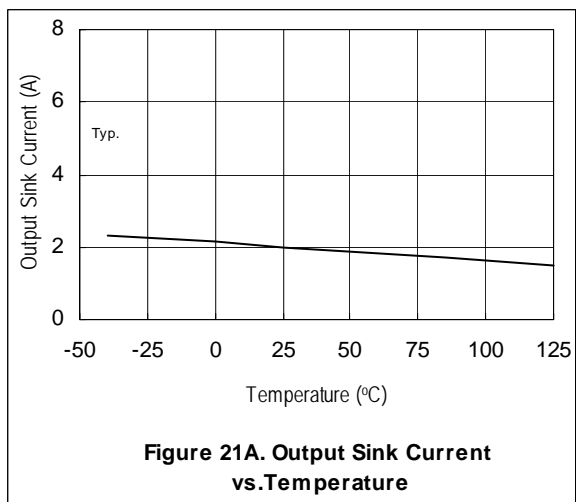
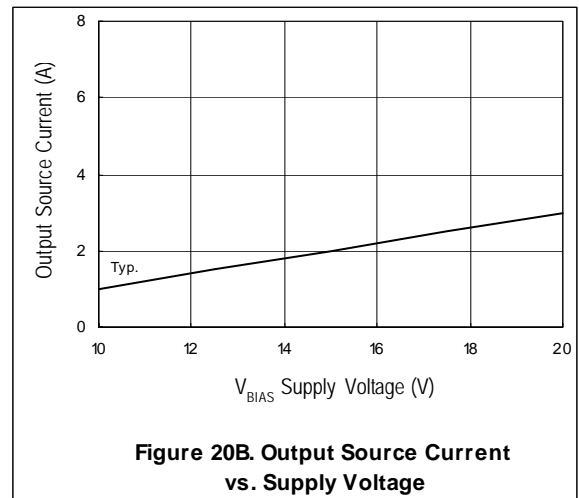
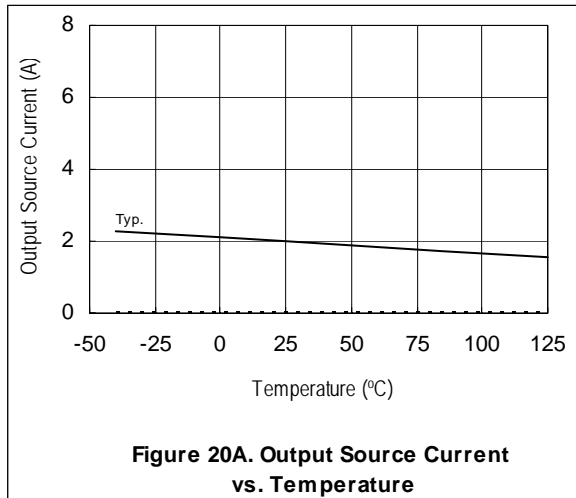

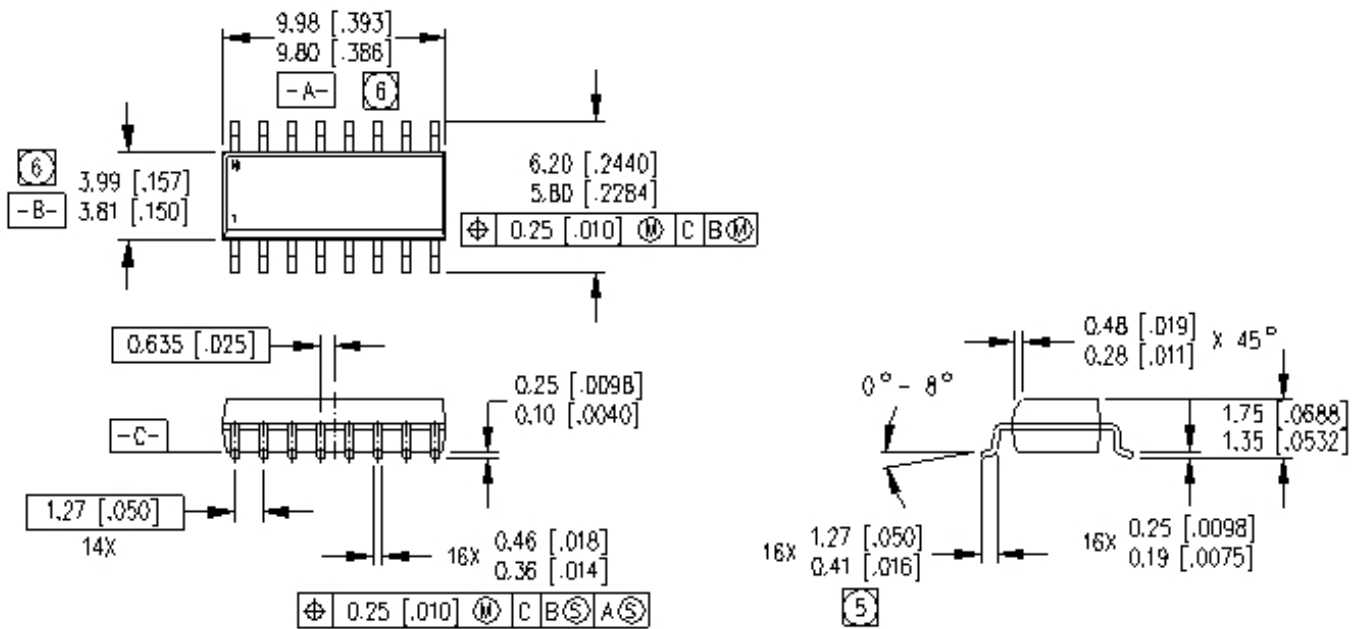

NOTES:

1. DIMENSIONING & TOLERANCING PER ANSI Y14.5W-1982
2. CONTROLLING DIMENSION. MILLIMETER
3. DIMENSIONS ARE SHOWN IN MILLIMETER [INCHES]
4. OUTLINE CONFORMS TO JEDEC OUTLINE MS-012AC
5. DIMENSION IS THE LENGTH OF LEAD FOR SOLDERING TO A SUBSTRATE
6. DIMENSION DOES NOT INCLUDE MOLD PROTUSIONS. MOLD PROTUSIONS SHALL NOT EXCEED 0.15 [.006]

16-Lead SOIC (narrow body)

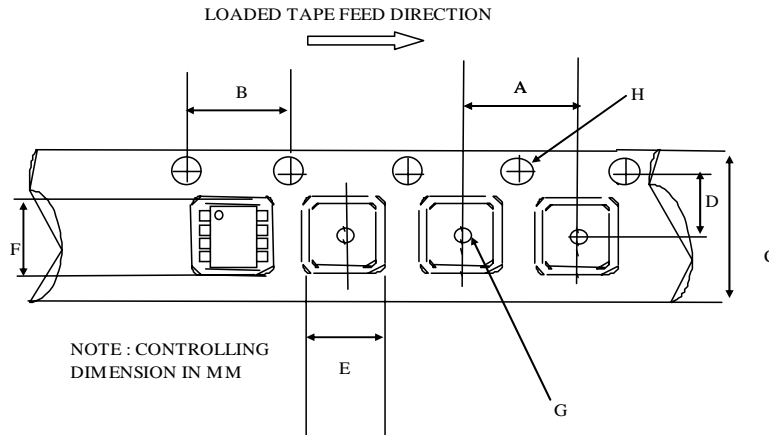

CARRIER TAPE DIMENSION FOR 16SOICN

Code	Metric		Imperial	
	Min	Max	Min	Max
A	7.90	8.10	0.311	0.318
B	3.90	4.10	0.153	0.161
C	15.70	16.30	0.618	0.641
D	7.40	7.60	0.291	0.299
E	6.40	6.60	0.252	0.260
F	10.20	10.40	0.402	0.409
G	1.50	n/a	0.059	n/a
H	1.50	1.60	0.059	0.062

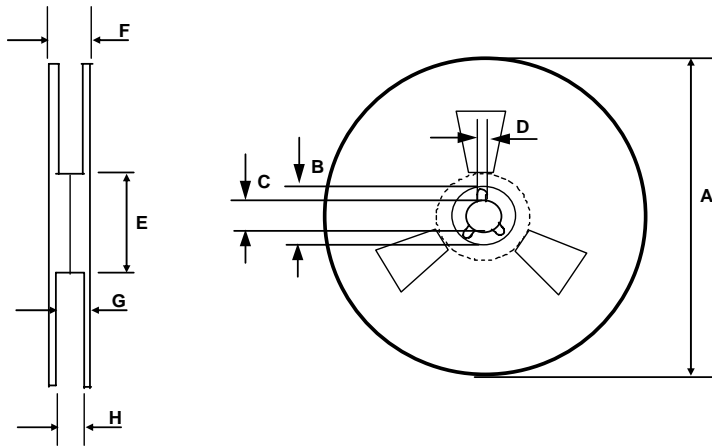

REEL DIMENSIONS FOR 16SOICN

Code	Metric		Imperial	
	Min	Max	Min	Max
A	329.60	330.25	12.976	13.001
B	20.95	21.45	0.824	0.844
C	12.80	13.20	0.503	0.519
D	1.95	2.45	0.767	0.096
E	98.00	102.00	3.858	4.015
F	n/a	22.40	n/a	0.881
G	18.50	21.10	0.728	0.830
H	16.40	18.40	0.645	0.724

LEAD-FREE PART MARKING INFORMATION

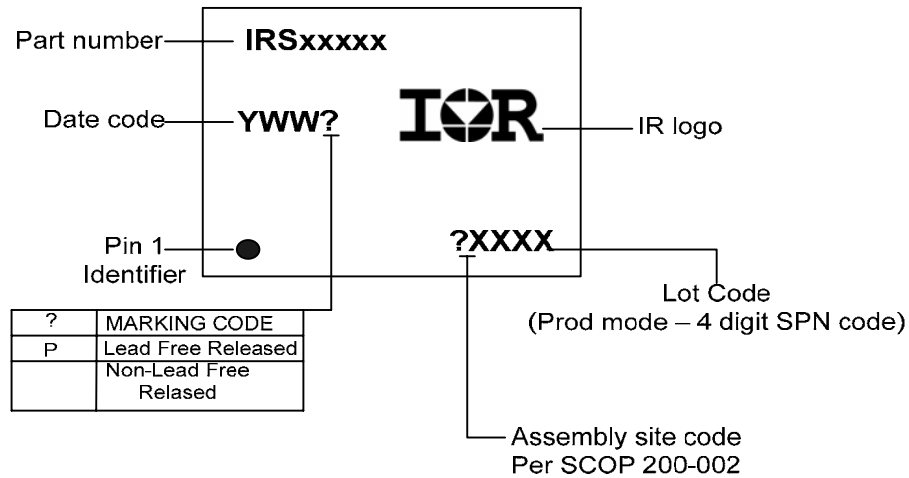

ORDER INFORMATION

16-Lead SOIC IRS21853SPBF

16-Lead SOIC Tape & Reel IRS21853STRPBF

SO-16N package is MSL3 qualified.

This product has been designed and qualified for the industrial level.

Qualification standards can be found at [IR's Web Site http://www.irf.com/](http://www.irf.com/)

WORLD HEADQUARTERS: 233 Kansas St., El Segundo, California 90245 Tel: (310) 252-7105

Data and specifications subject to change without notice

06/28/2007